

ARCHLine.XP® 2020

Windows

ADVANCED COURSE

Interior Design Tutorial

Information in this document is subject to change without notice and does not represent a commitment on the part of CadLine. The software, which includes the information contained in any databases, described in this document is furnished under a license agreement or nondisclosure agreement. The software may be used or copied only in accordance with the terms of the agreement. It is against the law to copy the software on any medium except as specifically allowed in the license or nondisclosure agreement. The licensee (purchaser) may make one copy of the software for the purpose of creating a -backup copy. No part of this tutorial may be reproduced, transmitted, transcribed, or translated into any language in any form or by any means, without the express written permission of CadLine.

2020 CadLine. All rights reserved.

In no event shall CadLine be liable for special, indirect or consequential damages in connection with or arising from the use of this document or any programs contained herein.

Microsoft, MS, and MS-DOS are registered trademarks and Windows is a trademark of Microsoft Corporation.

ARCHLine.XP® is a trademark of CadLine.

This tutorial was produced using Microsoft Word and ARCHLine.XP®.

Contents

1.	Workshop: Layer Management	9
1.1.	Layer properties.....	9
1.2.	Layer Walk tool.....	12
1.3.	Layer: The general property of objects	12
1.4.	Layer Control Mode	13
1.5.	Create a New Layer.....	13
1.6.	Move Objects to New Layer.....	14
1.7.	How to delete layers	15
1.8.	Layer filters	15
1.9.	Show visible layers only.....	16
1.10.	Layer variations	16
1.11.	How to use layers on plot layout.....	18
2.	Workshop: Design Phases	23
2.1.	Design phases.....	23
2.2.	Phase filters	24
2.3.	Graphic overrides	27
2.4.	Design phases on the sheets	28
3.	Workshop: Creating doors and windows.....	33
3.1.	Use an image to set the material of the door panel	33
3.2.	Convert a downloaded object to door/window	35
3.3.	Door/Window wizard.....	38
3.3.1.	Door with insert on the right side	38
3.3.2.	Door with an inset on the middle.....	44
3.3.3.	Door with three different insets	45
3.3.4.	Door with five different insets.....	48
3.3.5.	Door with decorative strips	49
4.	Workshop: Teamwork.....	55
4.1.	Basic concepts.....	55
4.2.	Setting up a team project.....	56
4.3.	Working in a team.....	57
4.4.	Refreshing the team project.....	57
4.5.	Working area administration – managing working areas	57
4.6.	Change active working area on the View Control Bar.....	58
4.7.	Reassign elements to a different working area.....	59
4.8.	Work offsite or offline	59
4.9.	Convert Team project into single-user project	59
5.	Workshop: Lighting plan	63
5.1.	Wiring layout.....	63
5.1.1.	Lighting fixtures.....	65
5.1.2.	Settings.....	65
5.1.3.	Switching between lighting fixtures symbolic and top view representation	67
5.1.4.	Multi-pole switches	67
5.1.5.	Assignment of switches and lamps	67
5.1.6.	Lighting plan- delete connection	68
5.1.7.	Lamps - Switches statuses	68
5.1.8.	Add further lamps to an existing circuit.....	69
5.1.9.	Room built-in power.....	70
5.2.	Socket layout	71
5.3.	Switch layout	72
5.4.	Lighting layout	75
6.	Workshop: Suspended ceilings.....	79
6.1.	Grid ceiling.....	79
6.1.1.	Creating grid ceilings	79
6.1.2.	Grid Ceiling Properties.....	79
6.1.3.	Rotate the grid layout on the floor plan	82
6.1.4.	Modifying units on the floor plan	82
6.1.5.	Add units on the floor plan	82
6.2.	Plain ceiling	84
6.2.1.	Creating plain ceilings.....	84

6.2.2.	Plain Ceiling Properties	84
7.	Workshop: Curtain walls	91
7.1.	Converting the 1 st office to closed-space	92
7.1.1.	Set properties	92
7.1.2.	Create and edit the curtain wall	93
7.2.	Converting the 2 nd office to closed-space	96
7.3.	Creating the meeting room	99
7.4.	Reshape the curtain wall	102
8.	Workshop: Framed walls.....	107
8.1.	Creating framed walls	107
8.1.1.	Setting framed wall properties	107
8.1.2.	Setting the framed structures' properties	108
8.1.3.	Show only the framed structure in 3D view.....	110
8.1.4.	Shifting the framing.....	111
8.1.5.	Placing studs in the structure manually	111
8.2.	Planning with grid lines	111
8.2.1.	Setting the default parameters of the grid lines	112
8.2.2.	Placing the grid lines.....	113
8.2.3.	Expanding the grid lines	115
8.2.4.	Checking the connected objects to the grid lines.....	116

Advanced Course Training Tutorial

We highly recommend the Advanced Course Training Tutorial to our potential and current ARCHLine.XP® users who successfully completed the ARCHLine.XP Preliminary and Intermediate Courses.

The course contains eight workshops:

Layer Management, Design Phases, Doors and Windows, Teamwork, Lighting Plans, Suspended Ceiling, Curtain walls, Farmed walls.

After accomplishing these workshops, you will be able to execute more challenging and advanced design tasks.

Enjoy the successful design!

CadLine

Start your design and work with ARCHLine.XP®

This training material is a guidance to help you to become familiar with the typical interior design examples, and enables you to create more complex designs. To get the most out of the tutorial, run the ARCHLine.XP® program and the appropriate YouTube video to try those features and tools which can be found in this training material.

To complete tasks please download **WORKSHOP PROJECT – ADVANCED** from our website and install to your computer. This contains all projects for Advanced workshops.

1. Workshop: Layer Management

1. Workshop: Layer Management

It is an often occurring task to display a floorplan in many various ways, according to the multiple plans such as Architectural floorplan, Furnishing plan, MEP plan, Electrical accessories plan, Tiling plan,...

CAD software offers the Layer Management as a solution. Layers are the primary method for organizing objects in a drawing, so objects of the current project can be grouped or separated according to various aspects.

In this workshop, we will demonstrate how to create layers to print different plot layouts based on the same floorplan.

- Open ...\\Documents\\ARCHlineXP Draw\\2020\\Advanced_Course\\1_Layer_management\\1_Family_Business_Office_START.pro file.
- Save it under a different name.
Before you start drawing, let's look through how layer tools are functioning. First, we check the layer properties.

1.1. Layer properties.

Important, the layer structure of the floorplan and the 3D view is not the same. Therefore, we have to launch layer tools on the floorplan.

- Activate the floorplan window.



- Click on the Layer button on the Statusbar. This way, you open the **Layer Properties Management**.
- Click on Used layers group under All layers.
Layers have the following main properties:

Layer Properties Management

The name of current layer: Wall - Load-bearing wall

Name	On	Lock	Printable	Elements	C...	Line-type	Line...	Description
Dimension - Architectural	☑	🔒	🖨️	65	■	Simple ...	0 mm	
Dimension - Electrical	☑	🔒	🖨️	54	■	Simple ...	0 mm	
Dimension - Interior	☑	🔒	🖨️	32	■	Simple ...	0 mm	
Dimension - MAP	☑	🔒	🖨️	7	■	Simple ...	0 mm	
Dimension - Opening dimension	☑	🔒	🖨️	9	■	Simple ...	0 mm	
Dimension - Tiling	☑	🔒	🖨️	132	■	Simple ...	0 mm	
Electrical accessory	☑	🔒	🖨️	308	■	Simple ...	0 mm	
False ceiling	☑	🔒	🖨️	40	■	Simple ...	0 mm	
Interior - Hall - Decoration	☑	🔒	🖨️	1660	■	Simple ...	0 mm	
Interior - Hall - Furniture	☑	🔒	🖨️	102	■	Simple ...	0 mm	
Interior - Kitchen - Decoration	☑	🔒	🖨️	163	■	Simple ...	0 mm	
Interior - Kitchen - Furnishing	☑	🔒	🖨️	265	■	Simple ...	0 mm	
Interior - Living room - Furnishing	☑	🔒	🖨️	94	■	Simple ...	0 mm	
Interior - Office - Decoration	☑	🔒	🖨️	3220	■	Simple ...	0 mm	
Interior - Office - Furniture	☑	🔒	🖨️	2572	■	Simple ...	0 mm	
Lighting	☑	🔒	🖨️	402	■	Simple ...	0 mm	
MEP	☑	🔒	🖨️	92	■	Simple ...	0 mm	
Moulding	☑	🔒	🖨️	24	■	Simple ...	0 mm	
Polygon	☑	🔒	🖨️	6	■	Simple ...	0 mm	
Raster image	☑	🔒	🖨️	1	■	Simple ...	0 mm	
Room area	☑	🔒	🖨️	10	■	Simple ...	0 mm	
Slab 1	☑	🔒	🖨️	14	■	Simple ...	0 mm	
Wall - Load-bearing wall	☑	🔒	🖨️	389	■	Simple L	0 mm	
Wall - Plasterboard	☑	🔒	🖨️	12	■	Simple ...	0 mm	

Filters

☐ Show visible layers only

[-] All layers

[-] Used layers

Layer filter restricts the layers displayed in the Layer list to the selected layers. Drag and drop the selected layers onto the layer filter

Variations

[-] Available variations

[-] All layers

[-] Architectural floorplan

[-] Build 3D model

[-] MEP plan

[-] Tiling plan

A layer variation saves all the layers with the current states. It helps switching between possible layer variations in one step.

Do not delete used layers

Copy to clipboard

☐ Protocol for Layer Naming

OK

Cancel

Visibility: Turning on and off layers

By turning layers on and off, you can select layers to display in the drawing window. The objects of turned-on layers (yellow bulb) are visible, and you can refer to them. You can turn the layers on which previously had turned off (grey bulb) any time, and then these become visible again.

Background: Locking and unlocking layers

By locking and unlocking layers, you can define which layers you can edit and select. Locked layers become background layers. Objects of these layers are visible, can be referred to them, but you cannot select or edit them.

Printable: On or Off

Here you can select layers to print. Non-printable layers appear with a printer with a cross icon on the list.

Colour, Line type, Line width:

- ❖ These features are active in **Layer control mode**.

The layer properties such as visibility, background, printable can be turned on/off one by one; or in groups.

Let's look through these properties in more details:



When the layer is turned on and unlocked:

- ❖ its objects are **visible**
- ❖ you can **refer** to its objects
- ❖ its objects are **editable and selectable**



When the layer is turned on and locked:

- ❖ its objects are **visible**
- ❖ you can **refer** to its objects, but
- ❖ its objects are **not editable or selectable**



When the layer is turned off:

- ❖ its objects are **not visible**, therefore
- ❖ consequently, you **cannot refer** to its objects, and
- ❖ its objects are **not editable or selectable**



The active layer is always visible and unlocked.

Turning on/ off More layers all at once

There are situations when it is necessary to turn on/off more layers. Select more layers by holding down the SHIFT or CTRL key, and now it is enough to change the visibility of one layer. Now all the rest of the selected layers inherit the property of the currently selected layer. All layers can be selected by pressing CTRL+A.

An example of how to turn on and off layers

Activate the floorplan.

- Select the Layer walk tool and click on “**Wall-Load-bearing wall**” and „**Slab**” layers by holding down the CTRL-key.
- Now create the 3D model by using the Quick 3D model tool.
The result is the following:

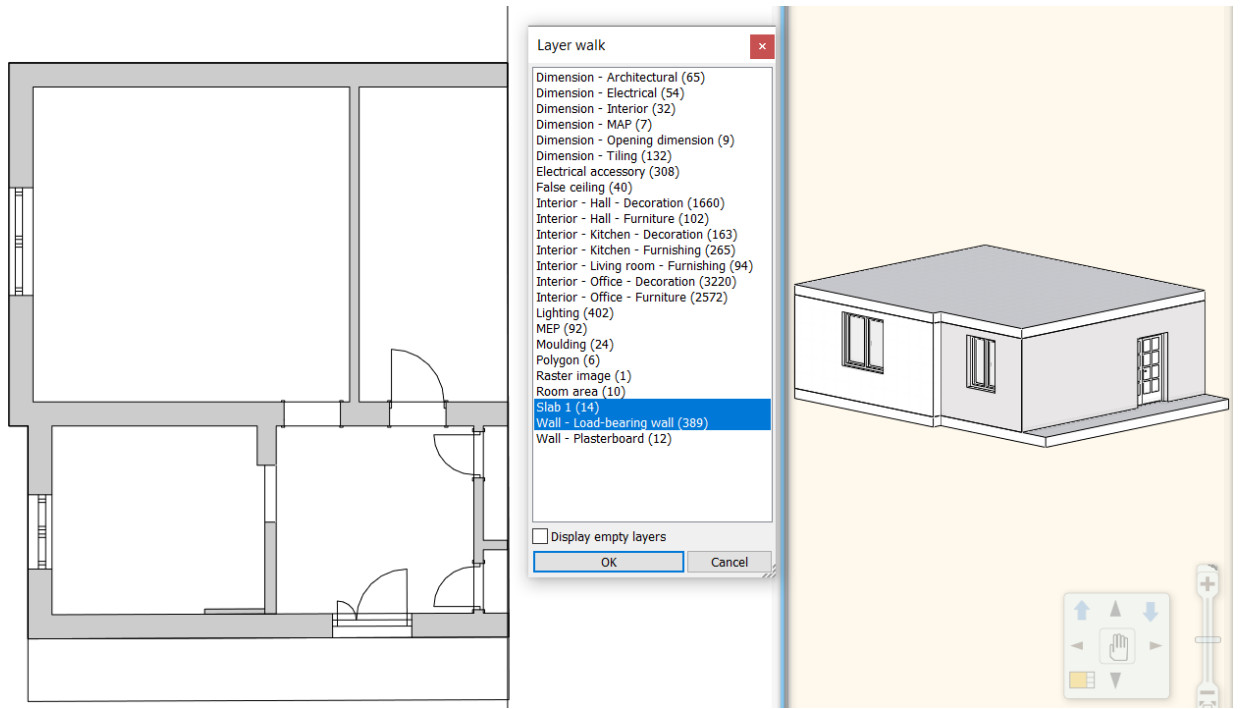

In the Layer Properties management window, we can check that both layers are turned on and unlocked. This way, these layers are visible, editable, selectable so, the 3D model is created.

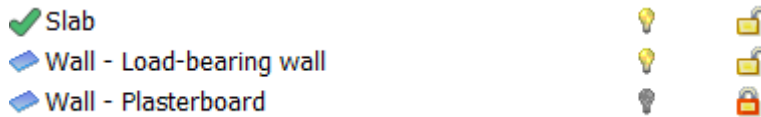

- Lock the “Wall-Load-bearing wall” layer, now rebuild the 3D model.



The **Wall-Load-bearing wall** layer turned to the background layer. Walls are not visible, not editable, and cannot be selected on the floorplan. Only the slabs are displayed.

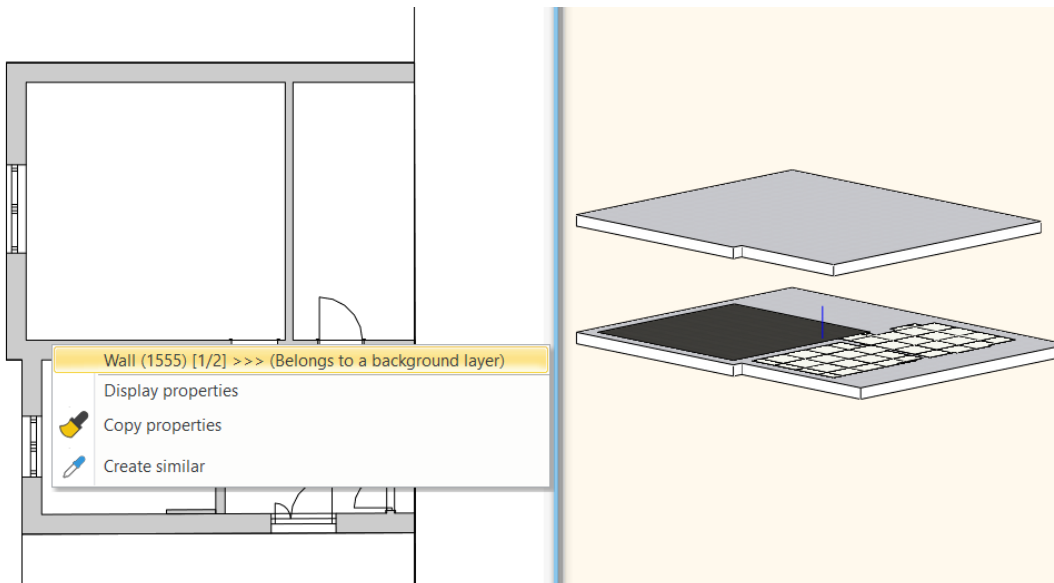

1.2. Layer Walk tool

Layer Walk tool helps to navigate through the existing layers. The Layer Walk makes it easy to turn on and off layers; or create a new combination of the visible layers. Next to the layer name is indicated the number of the elements on that given layer in brackets.

When the Layer Walk window is open, the visible layers are highlighted, and accordingly, the objects on these layers are displayed on the active floorplan.

More layers can be selected by holding down the CTRL button and clicking on the layer name.

Layers between the first and last selected layers can be selected by holding down the SHIFT button on your keyboard. This also can be done by using the mouse.

In addition to **Wall, Wall – Load-bearing wall layer** select every **Interior layer** and rebuild the 3D model. The result is the following.

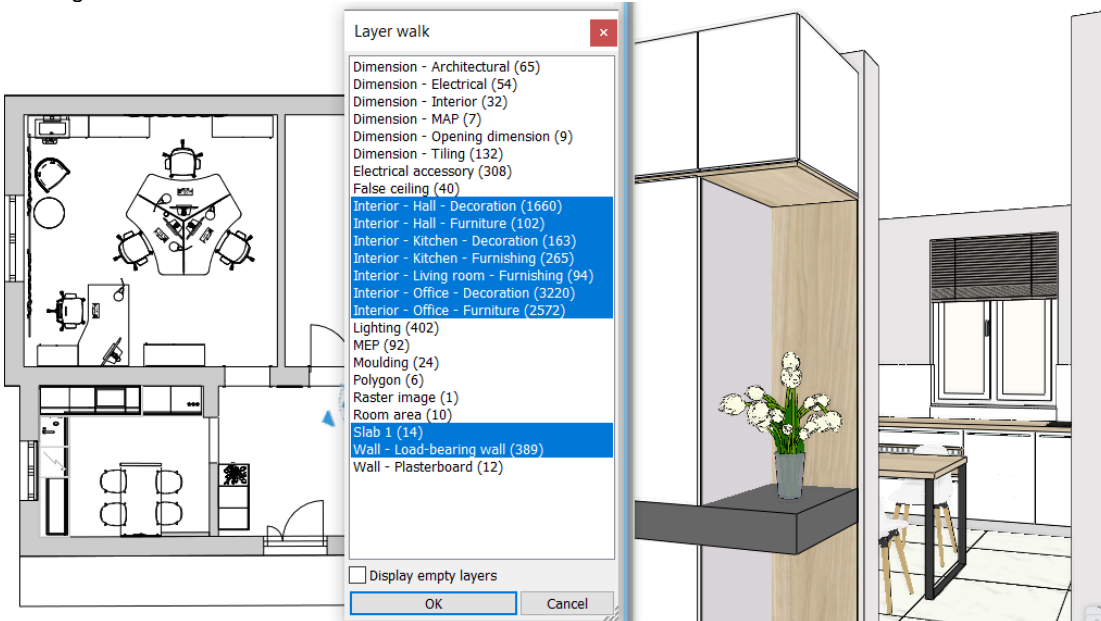

Now activate the 3D view. Let's use the Layer Walk tool.

The Layer List is not the same as it is on the floorplan; the locked layers are not displayed.

1.3. Layer: The general property of objects

How can happen that objects are automatically placed on different layers?

In ARCHLine.XP, each project is built up from different layers, even if you don't do anything to organize the content on layers. If you open a blank project, the program already contains default layers. When we create new architectural, interior, or drawing objects, these are automatically placed on that layer, which is defined by the given object type.

When we define the general properties of the object types, you have to specify the layer where the new elements of the given object type will be placed. The program has a pre-defined layer list. Each object type is assigned to a layer; the new element will be automatically assigned to it. The assignment can be modified.

For example, *1 layered 38 wide wall* will be assigned to the *Wall-Load bearing wall* layer, while *1 layered 06 wide wall* will be assigned to *Wall- Partition wall* layer, dimensions to *Dimension-Length*, furniture are assigned to *Interior- Living room- Furnishing* layer.

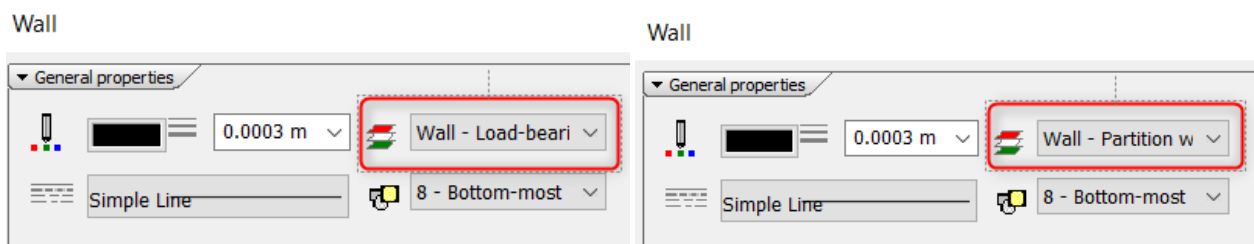

1.4. Layer Control Mode

On Ribbon bar under **Edit menu - Layer control mode option is turned off** by default.

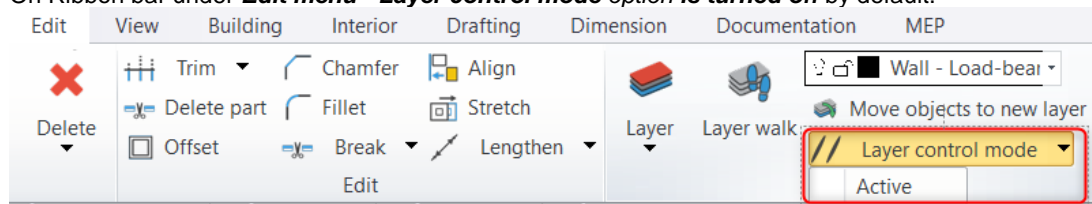

If you activate this mode, you can override the objects' general properties when you create a new object. In this case, that colour, line type, line weight will be applied which corresponds to that layer which is assigned to the new object.

The Layer Control Mode secures the AutoCAD compatible drawing method. When this option is active, you can still create objects with different colour, line type, line width, but these are only editable afterwards.



The display performance can improve in case of architectural and interior design plans if objects only, and not layers have own colour, line type, line weight.

So, this way, on the same layer, you can place objects with different properties (different colour, line type, line width, and even different types), and those can be managed together for various aspects.

1.5. Create a New Layer

A new layer can be created if All layers filter is active on the right side of the panel. By pressing the Add new layer button, the Layer:1 is made, by double-clicking on it, you can name it. (you can name any existing layer in the same way). The active layer indicated by a green tick.

- Click on *All Layers* filter.

Now all layers appear. We have already prepared layers for architectural elements and furnishing. These are automatically assigned to objects' types. In case there is another room on the floorplan which is not on this list, then it worth to create a new layer for it.

On this floorplan, there are three rooms, such as **Kitchen, Office, and Hall**.

First, we create layers for the Office and the Hall, then for the Furnishing. Automatically furniture already has been placed on the Interior – Living room – Furnishing layer.

Next, we will move objects to the new layers.

- Click on the *Add new layer* icon. Now the Layer: 1 is created and name it to *Interior – Hall – Furnishing* and *Interior – Office – Furnishing*.

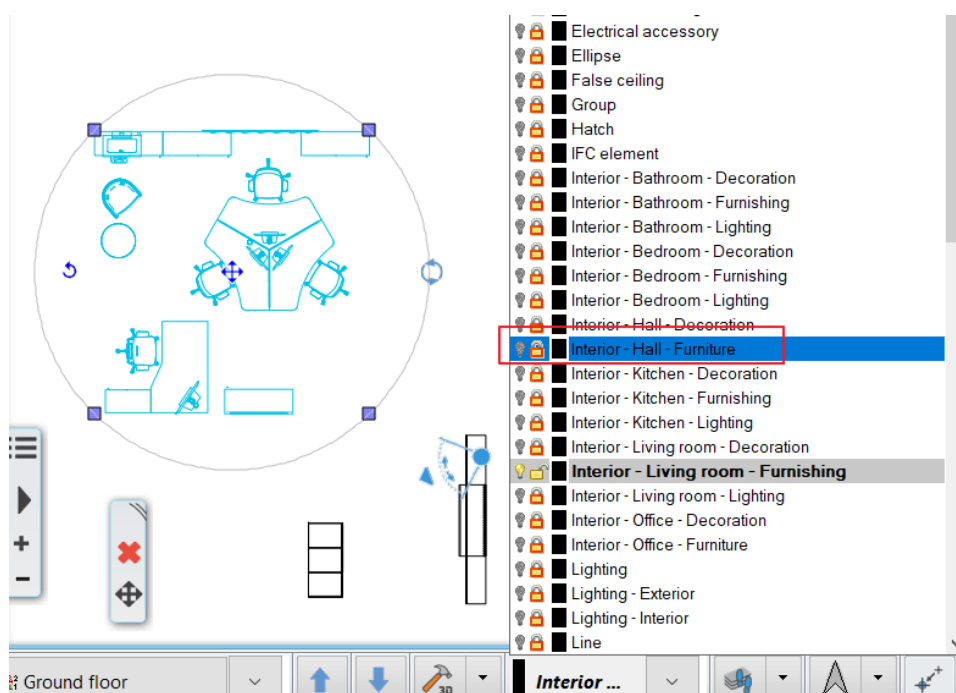

1.6. Move Objects to New Layer

Now we move the office and hall furniture from *Interior-Living room- Furnishing layer* to the newly created *Interior – Hall – Furnishing* and *Interior – Office – Furnishing* layers.

Display the content of the *Interior – Living room - Furnishing* layer by using the Layer Walk tool.

Select objects in the office and move these items to *Interior – Office – Furnishing* layer by selecting it from the Layer list panel on the Statusbar.

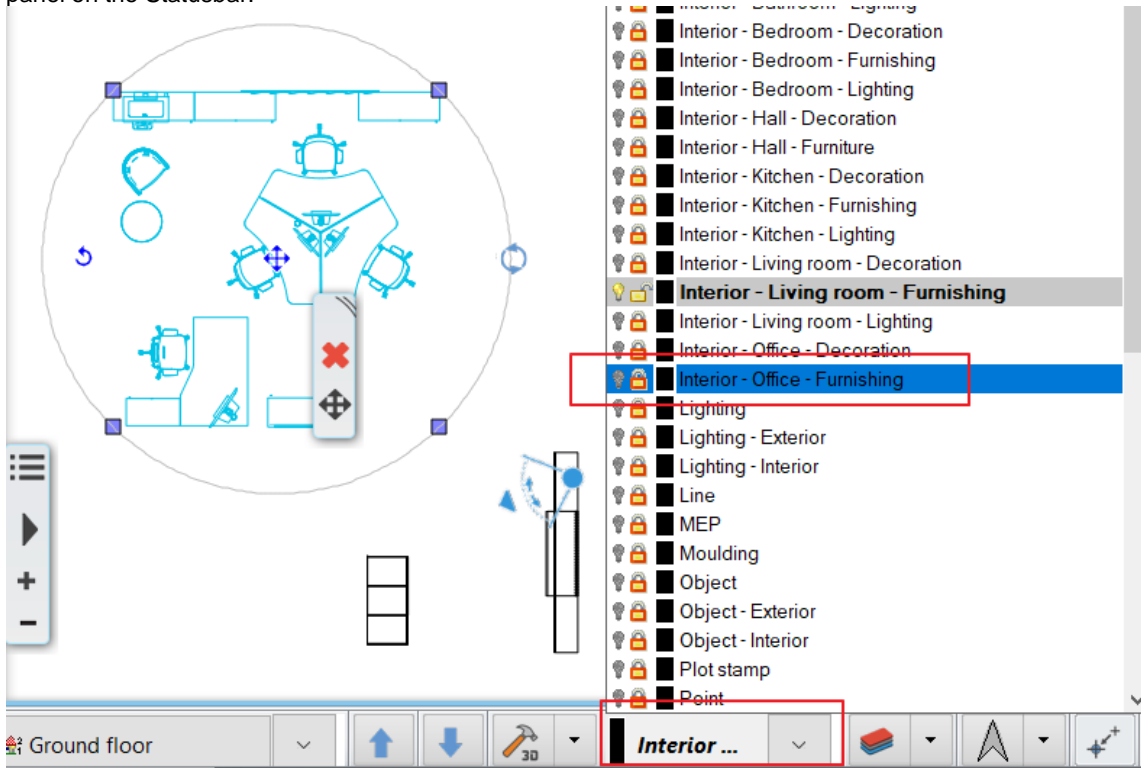

Now display the new layer content by using Layer Walk tool again:

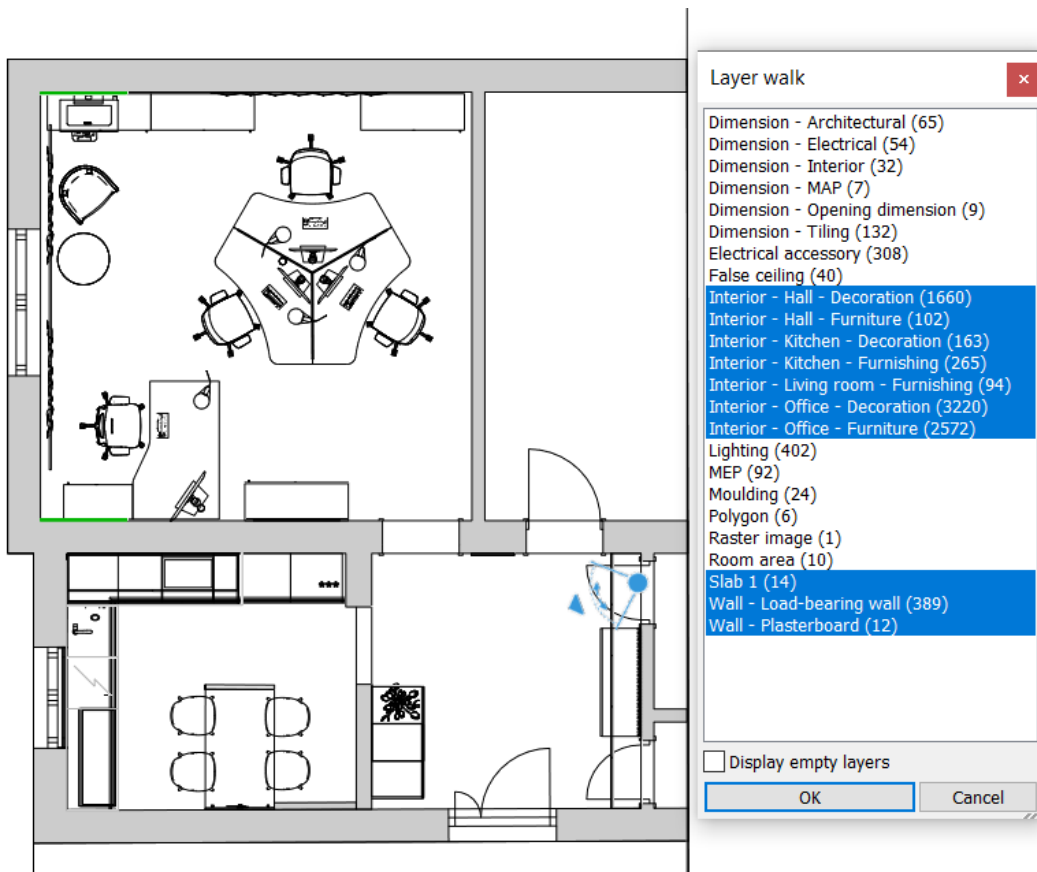

How to check the layer properties of objects

After replacement we have to double-check that objects in the hall are assigned to the *Interior – Hall - Furnishing* layer:

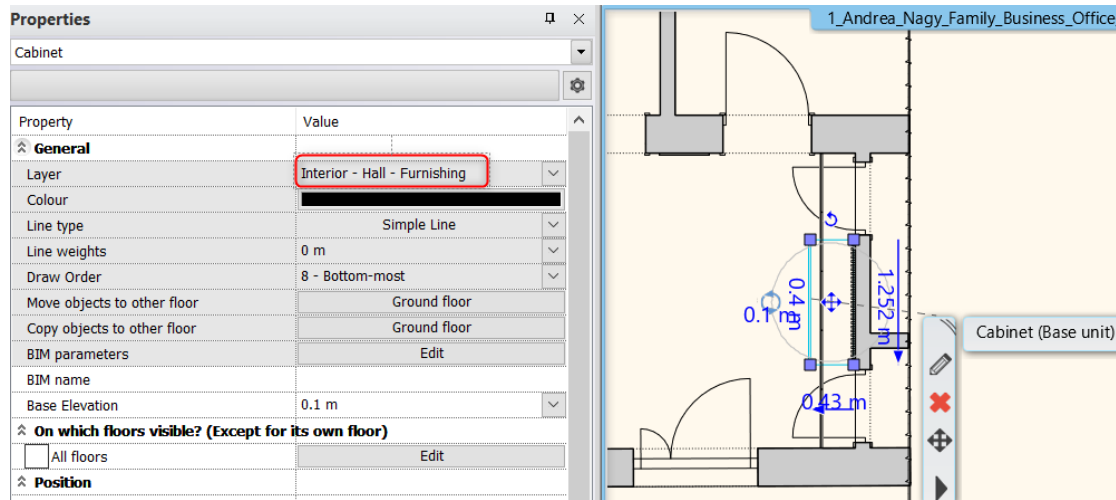

1.7. How to delete layers

Note that we cannot delete the active layer (before that we have to activate another layer), also by default, it is not possible to delete layers with elements.

Delete empty layer

In Layer Properties Management window, click on “Elements” header, this way, we can sort the layers in descending or ascending order depending on their content. Empty layers (0) show zero elements, and these can be selected and deleted by using the Delete icon on the top left corner.

Delete layers with elements

In the left bottom corner of Layer Properties Management dialogue window, we can toggle on the “Also delete used layers and content” option; this way, it is now allowed to remove layers with content.

NOTE! When this happens, you will get a warning, and the layer removal cannot be withdrawn. Check if you don't need the layer before permanently delete it containing elements.

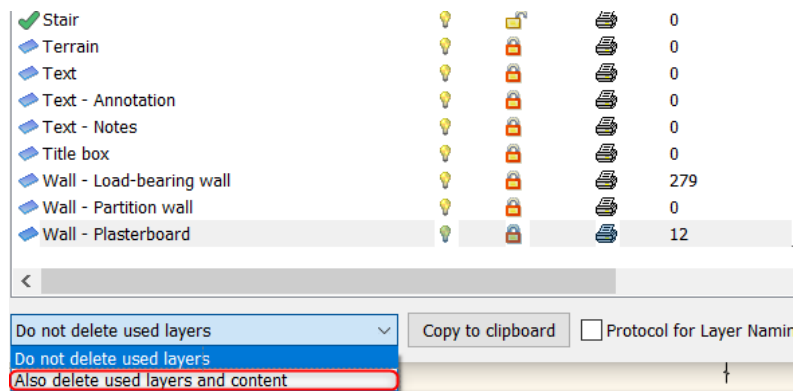

1.8. Layer filters

In the case of more complex projects, there are tools for organizing it more effectively. The Layer Filter is an excellent tool for that; we can create different groups of layers. Starting the program “Used Layers” filter is created by default, and layers with elements can be filtered.

Clicking on the Blue cross icon, we can create a new filter group, and you can rename the group by double-clicking on it. Now select layers on the left side of the panel, drag and drop them on the new filter group. Now, for example, we can create a filter that contains all Interior layers. By using the new filter, we can easily and quickly find any layers in a shorter list.

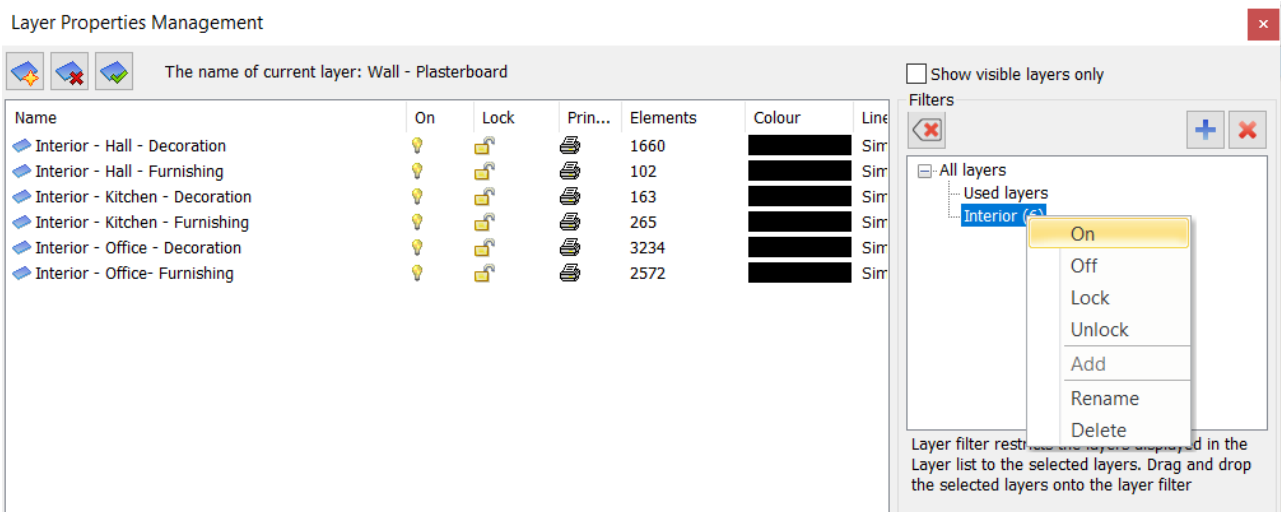

When importing a DWG file, the layers are automatically placed on a separate filter for better categorization.

One layer can be used in different filter groups and can be removed at any time. For this, use the red cross icon on the top left corner of the filter panel. Now the selected layer will be removed from the filter group, but will not be deleted. The removed layer still can be found under All layers, Used layers, or any other filter groups.

There is an option to remove a filter group. Layers of the filter group will not be deleted; only the filter group ceases to exist.

1.9. Show visible layers only

In the case of a large number of layers to increase the visibility, it can be useful to display only the visible layers. By activating *the Show visible layers only*, we can filter layers turned on.

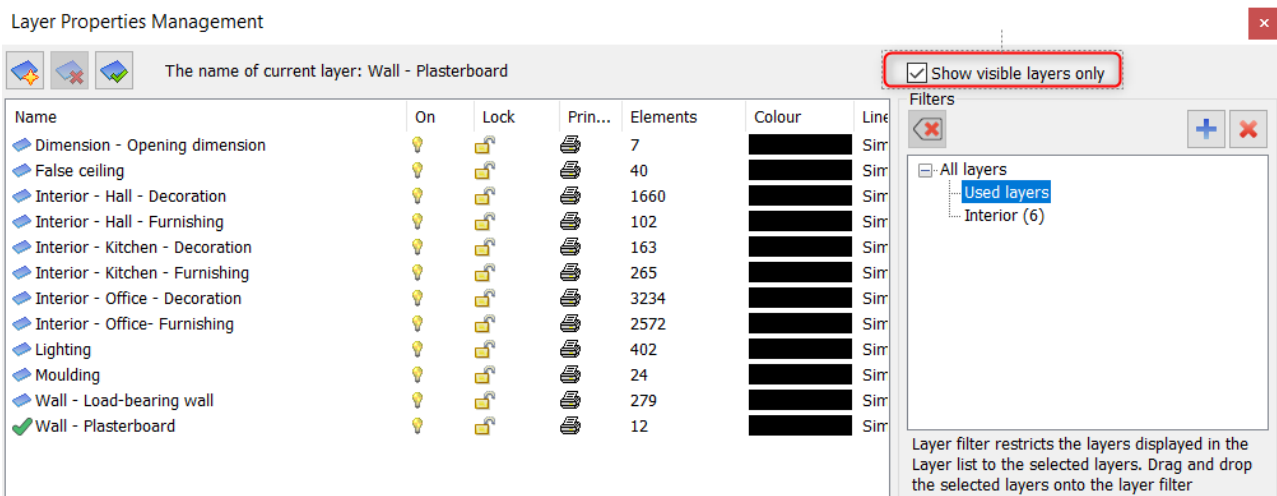

1.10. Layer variations

Now let's go back to our project:
Let's create the following plot layouts:

1. Architectural floorplan
2. Furnishing plan
3. MEP plan
4. Electrical accessories plan
5. Tiling plan

We use Layer Variations to solve these tasks. The aim is to change all at once the status of layers, which are grouped in a certain aspect.

Turn off and lock layers and then all layer settings can be saved as a new variation, by clicking on the Blue cross icon. The new variation group can be renamed by double-clicking on it.

If you need another variation, click on the Blue cross icon again. Now the current variation is copied; name the new variation. Then modify layers which are different from the current settings, finally press the Refresh button, to accept changes.

If you want to modify an existing variation, the method is the same as above. Change layers settings and override changes by using the Refresh button.

Layer variations can be selected on View Control Bar, one single click to choose and activate any of them.

Now let's create Furnishing and Electrical accessories plan:

Furnishing plan - Layer variation

- Now create the new variation, as it is shown in the picture below.
- Change the visibility of the layers.
- Now refresh the Furnishing layer variation.

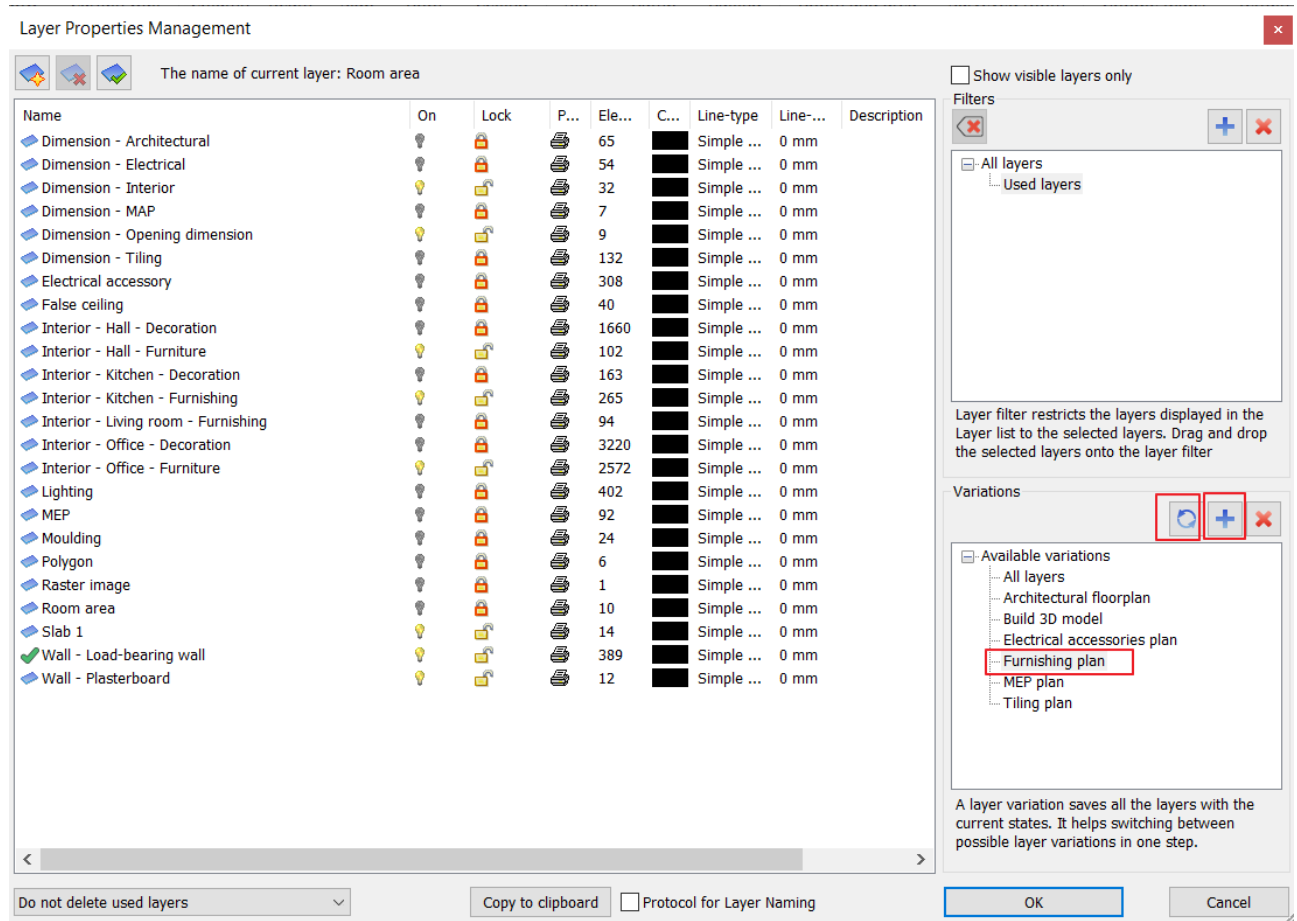

Electrical accessories plan - layer variation

- Now create the new variation, as it is shown in the picture below.
- Change the visibility of the layers.
- Now refresh the Electrical accessories plan layer variation.

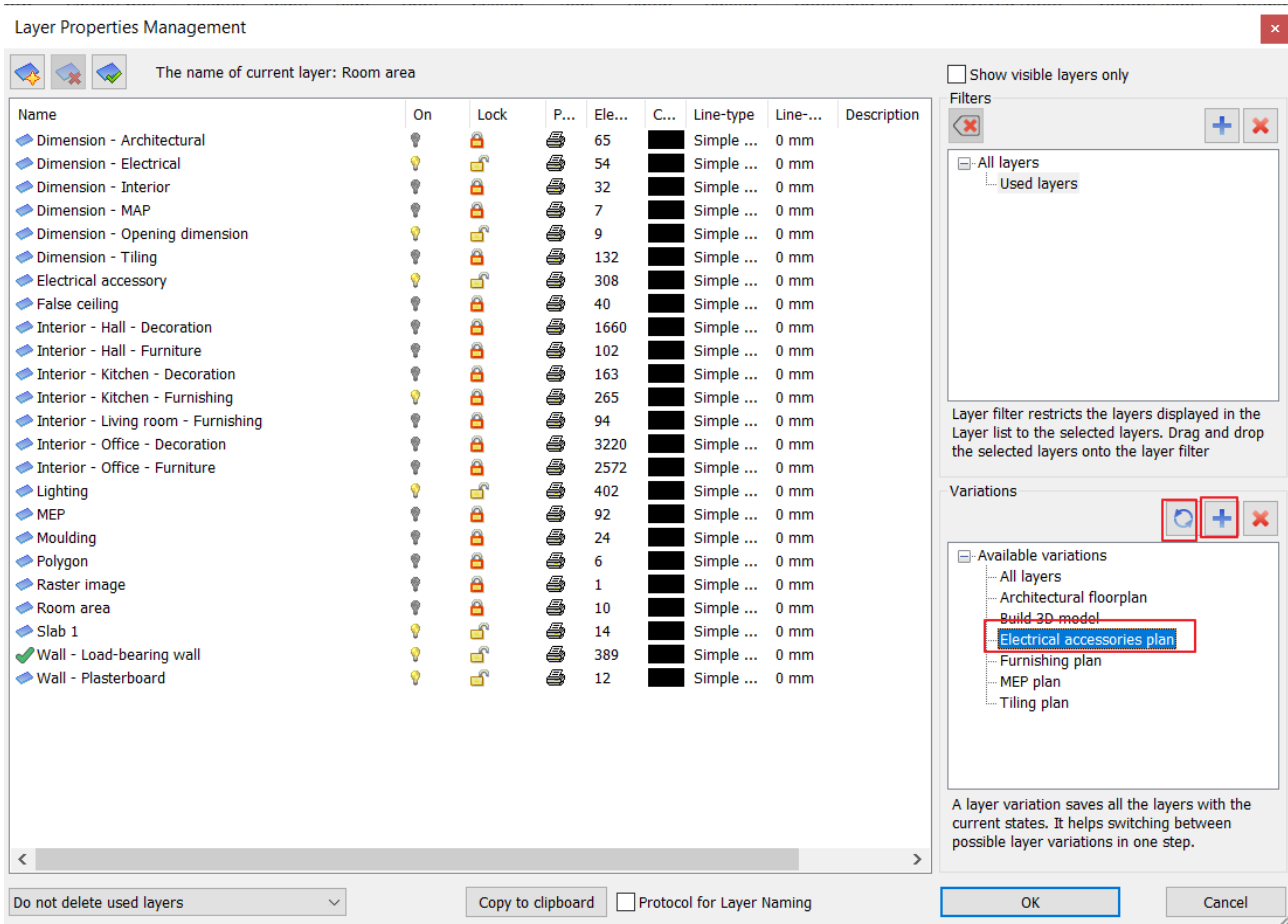

Now modify the 3D build layer variation because of 2 new layers:
Interior-Hal-Furnishing and *Interior – Office- Furnishing*

1.11. How to use layers on plot layout

Based on the layer variations, let's create one by one the following plot layouts:

1. Architectural floorplan
2. Furnishing plan
3. MEP plan
4. Electrical accessories plan
5. Tiling plan

In the project *1_Family_Business_Office_START.pro*

1. *Architectural floorplan*,

2. *MEP plan*,

5. *Tiling plan*

plot layouts are ready.

The 2. *Furnishing plan* and 4. *Electrical accessories plan* plot layouts are empty. Fill them.

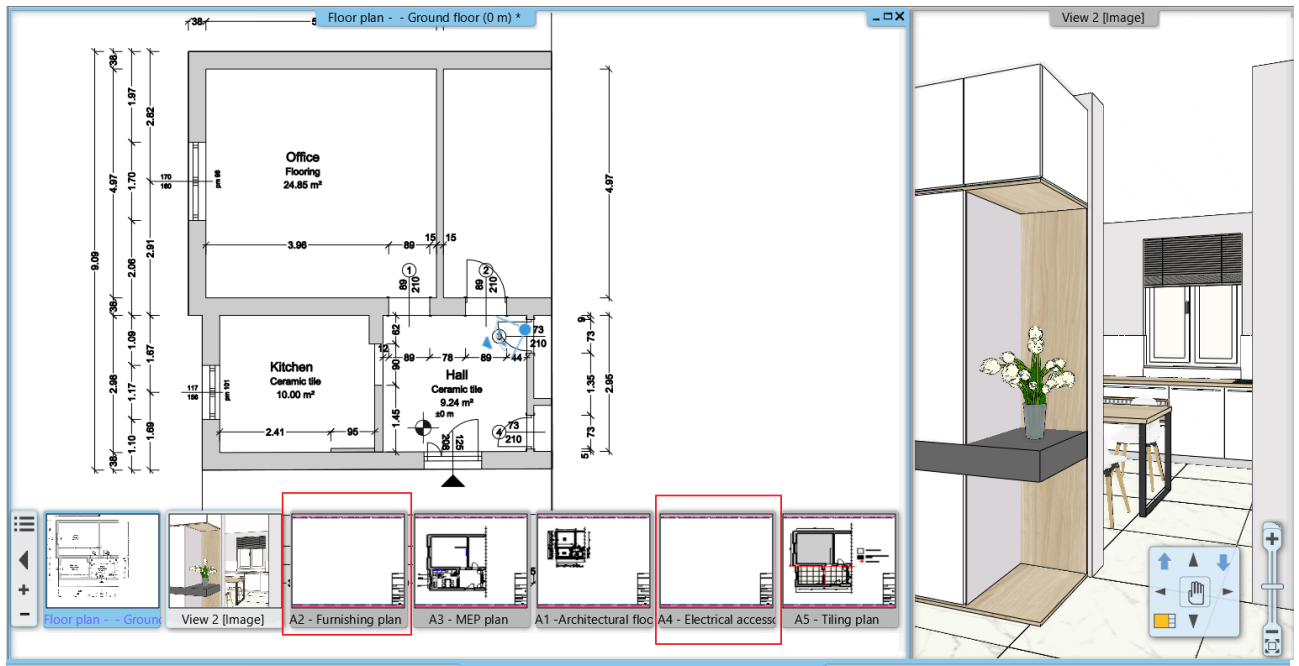

A4 - Electrical accessories plan *

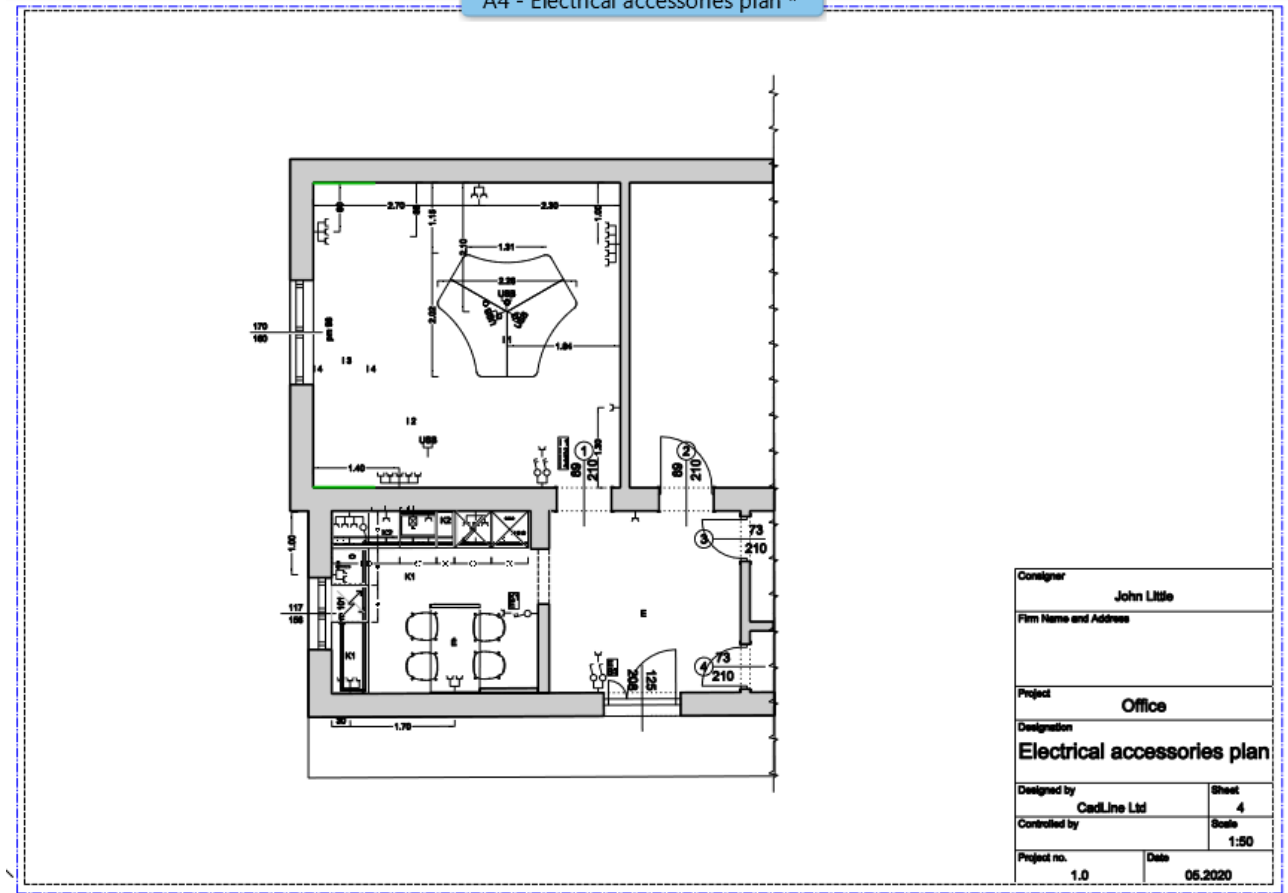

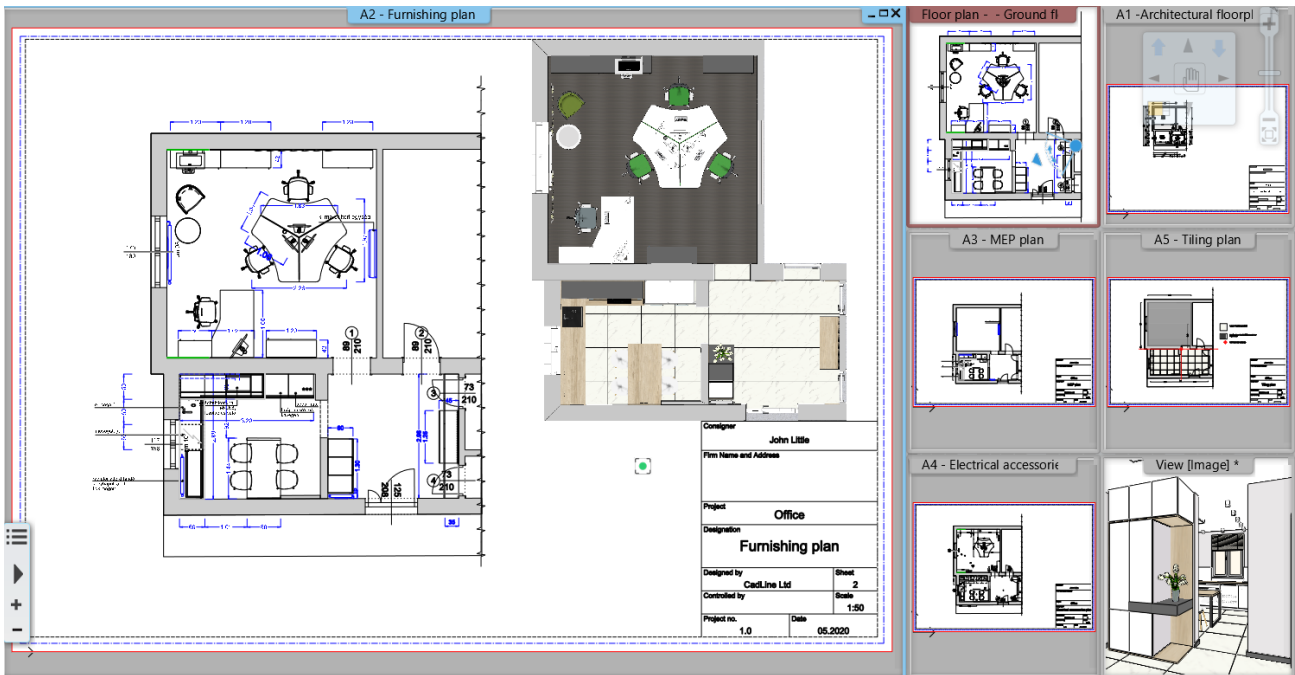

Now using the Print Queue tool save these plot layouts under one PDF file. We can create one PDF file from multiple drawings by giving the same path and file name to each drawing.

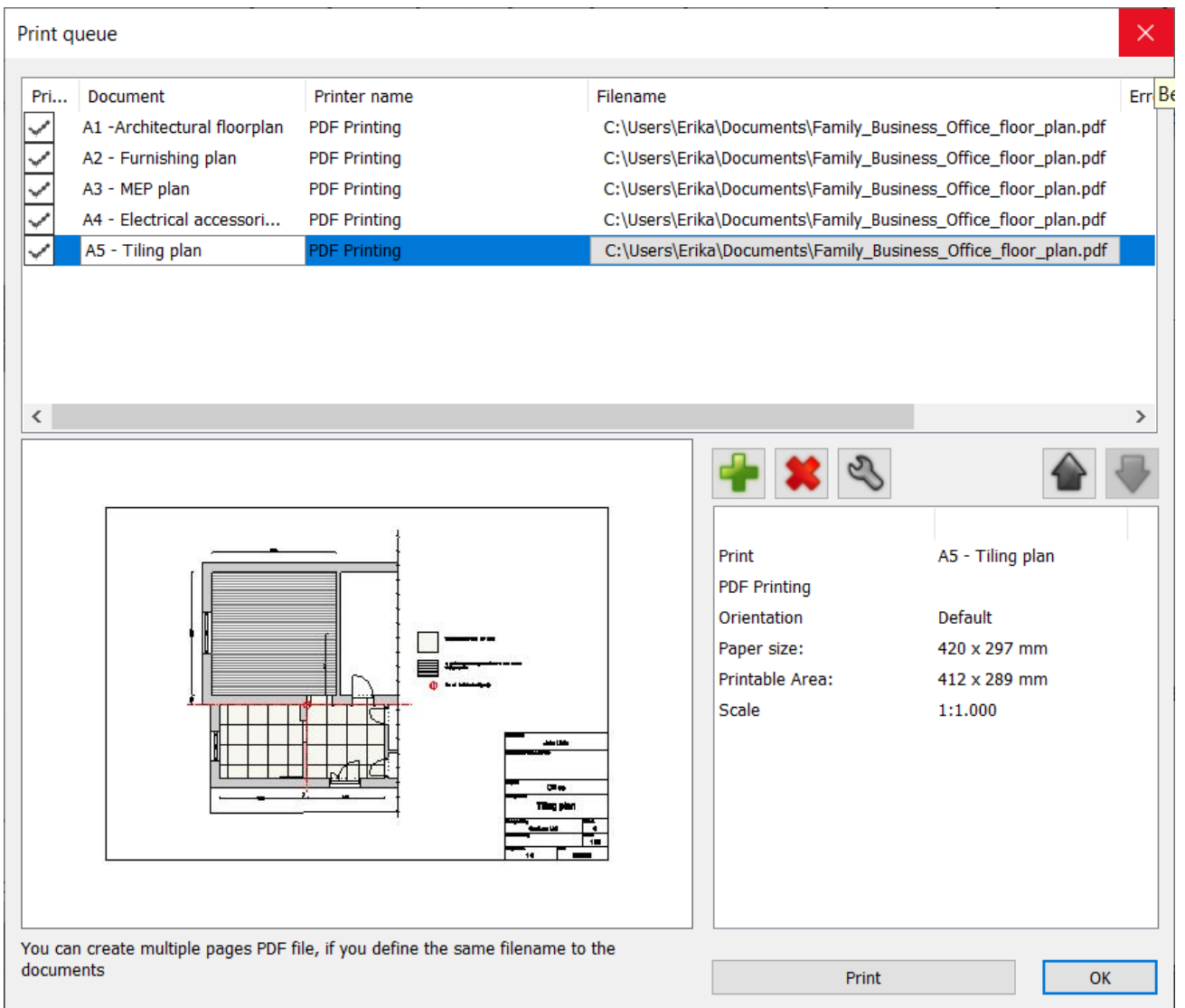

2. Workshop: Design Phases

2. Workshop: Design Phases

Using the design phases, it is possible to present the existing status and the new construction plan simultaneously in a single project file on the same drawing. Using phase filters, all stages of the design process can be demonstrated. Renovating buildings or planning more complex projects is significantly simpler using the design phases.

A huge advantage is that when modifying elements that appear in all phases of design – for example, when we want to correct the inaccuracies of the survey – changes appear immediately in all phases, since we are talking about the representation of the same element at different times.

- Open ARCHLine.XP® and select the *elata_nova_FINAL_Surrounding.pro* project on the welcome screen:



2.1. Design phases

The four main phases of the planning process:

1. **Existing state** (recording survey data)
2. **Demolition plan** (representation of the parts to be demolished)
3. **Existing plan after demolition** (elements have been demolished)
4. **New construction plan** (realized condition after renovation)

The phases that can be used during planning can be: Existing or New.

Creating a new item is always assigned to the current phase (Existing or New)

An item cannot be created in the Demolition phase. Items marked for demolition from New or Existing phases are added to the Demolition phase.

The phases can be followed throughout the documentation in the form of a 3D view, sections, elevations and a material overview.

Setting the phases

There are several ways to categorize each element:

- ❖ Select the Ribbon bar / Edit / Phases option. After selecting a phase from this menu you can select the objects on the floor plan or in the 3D view for which you want to validate the selected view.

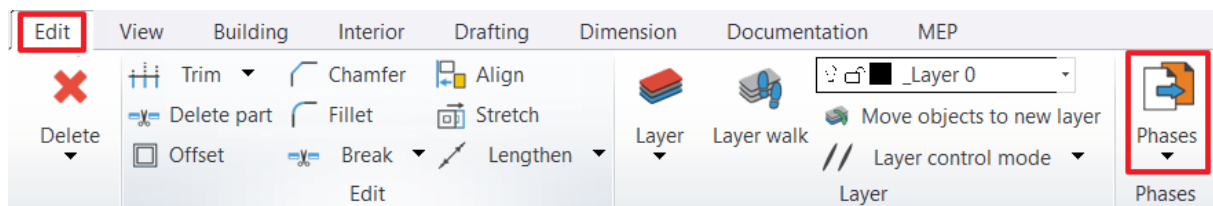

- ❖ You can move the selected item to the appropriate phase by right-clicking the item or selecting the item and selecting the additional options then clicking on the Phase.

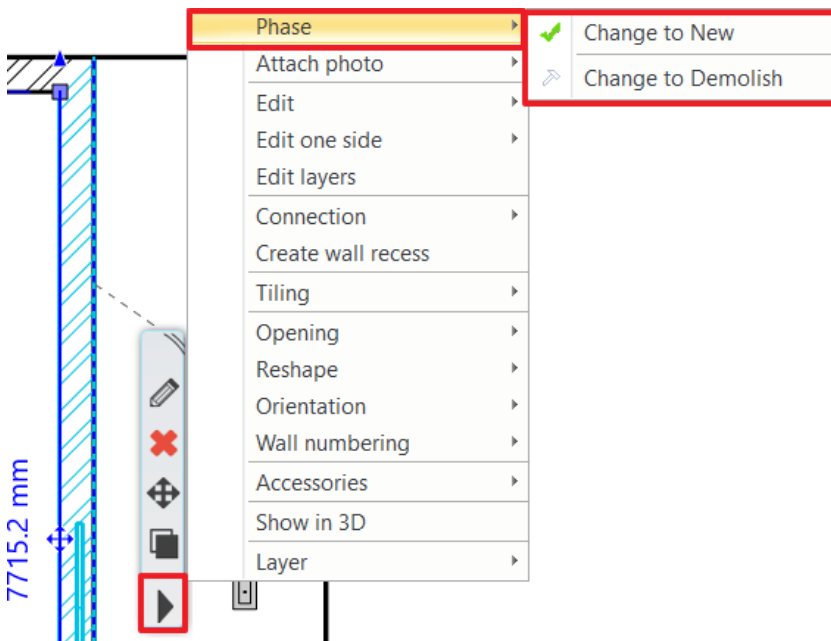

Phase settings for drawing elements

During the designing process, we can not only work with basic objects, but also depict certain details with other additional elements. When setting phases, you can therefore set not only which phases to display on walls, doors, and roofs, but also other objects, 3D elements, and drawing 2D elements, as well as scaling. This makes it much easier to use this feature during the designing process.

Phases for scaling

Scaling is in a special situation compared to other drawing elements because they are almost always related to another element depicted in some phase. Here, therefore, we distinguish two main cases

- ❖ If the scaling scales the element(s) that are entirely in the same phase, the scaling disappears or is displayed when the phase is turned on / off.
- ❖ If the scaling scales elements in two different phases, it does not belong to either, in which case it will still be visible when any phase is switched off.

2.2. Phase filters

Phase filters are representation rules for displaying elements by status (New, Existing, Demolition): ARCHLine.XP® has 5 phase filters:

1. All phases
2. Existing plan
3. Demolition plan
4. Existing plan after demolition
5. New construction plan

In the Drawing Status Manager, on the left are the various phase display settings. When you place Existing or New items, the program automatically places the objects in the appropriate phase.

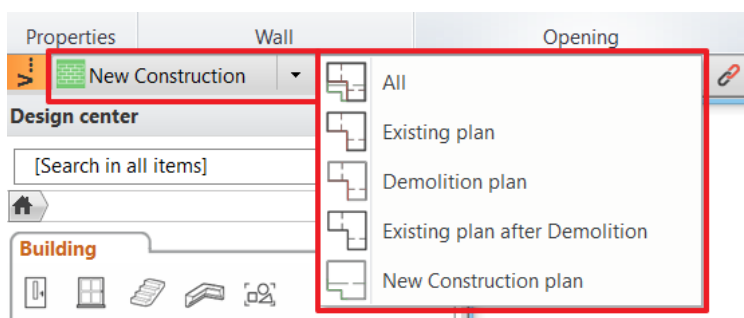

It is possible to categorize items not only before they are drawn, but you can change this setting at any stage of the workflow in one of the ways described earlier.

Appearance of phases

The images below show examples of Existing Plan, Demolition Plan, Post-Demolition and New Construction Phases.

Existing state

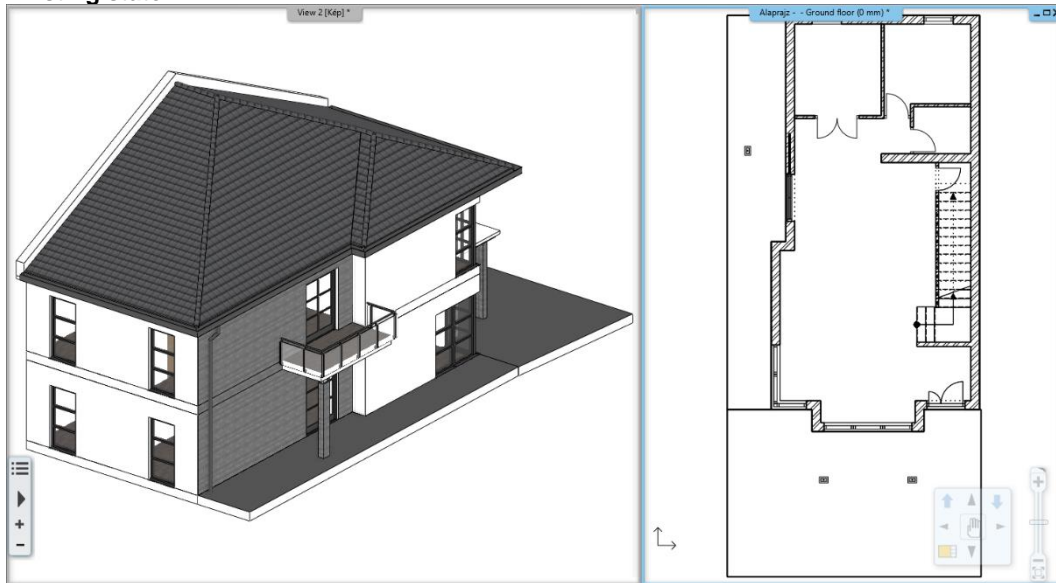

Demolition plan

ARCHLine.XP® automatically marks the elements to be decomposed in red on the floor plan and in 3D.

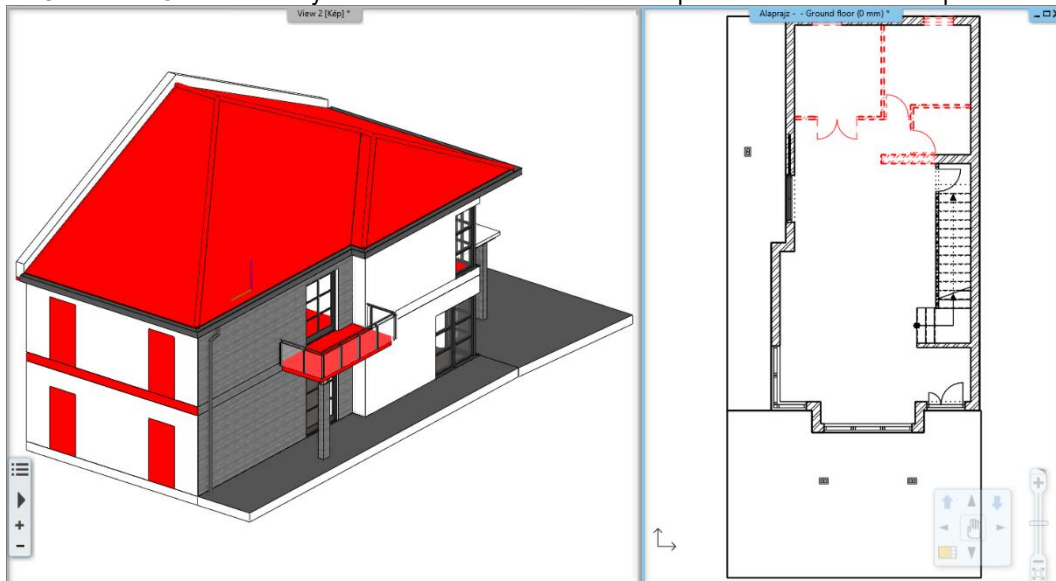

Existing plan after demolition

ARCHLine.XP® in 3D depicts empty spaces created in place of removed elements along with the remaining structures.

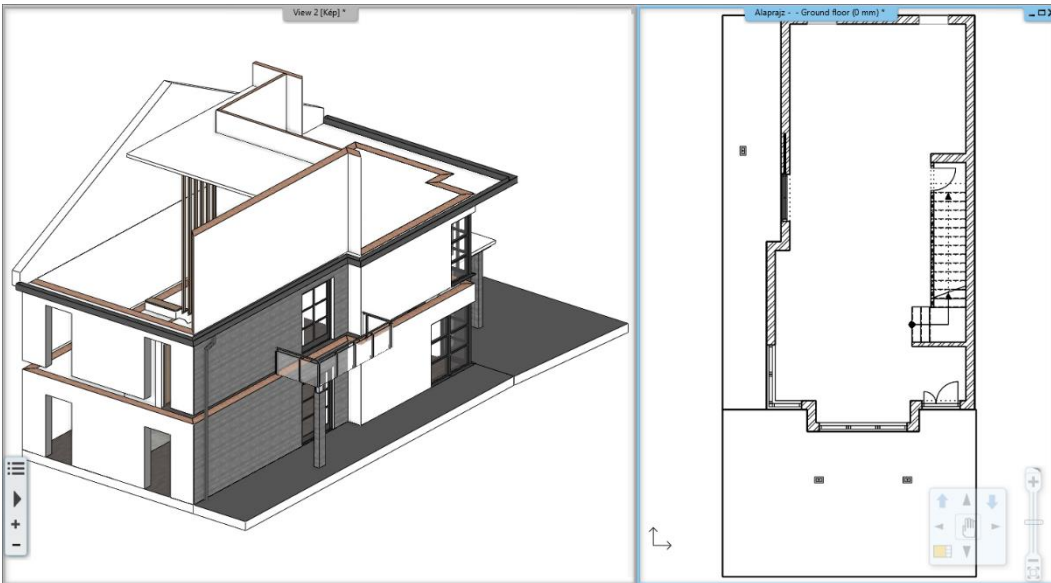

New construction plan

The remaining and newly designed items are visible at the same time.

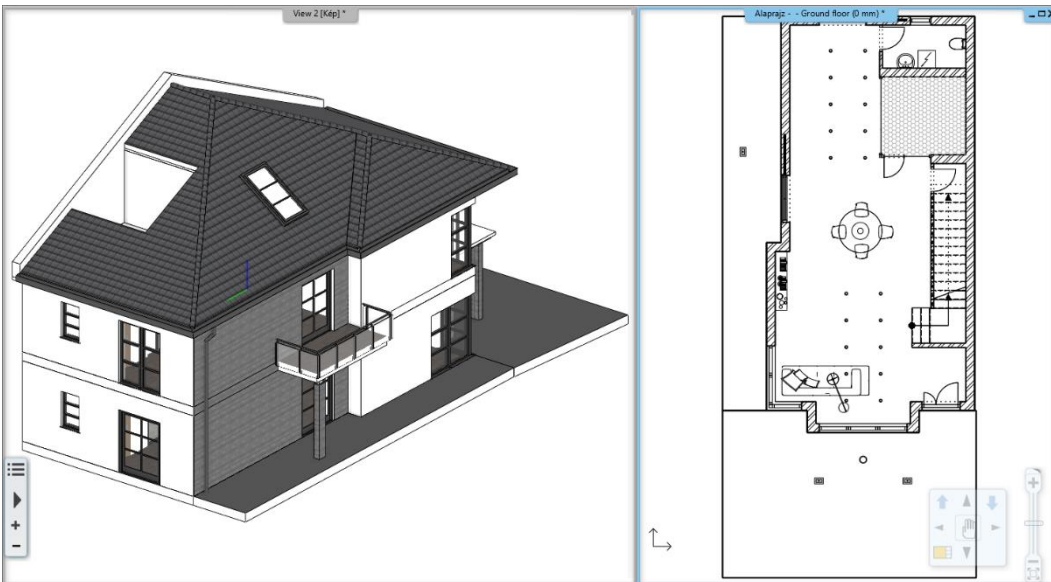

All phases

ARCHLine.XP® displays the elements of all phases at once. Useful representation for alignments and checks.

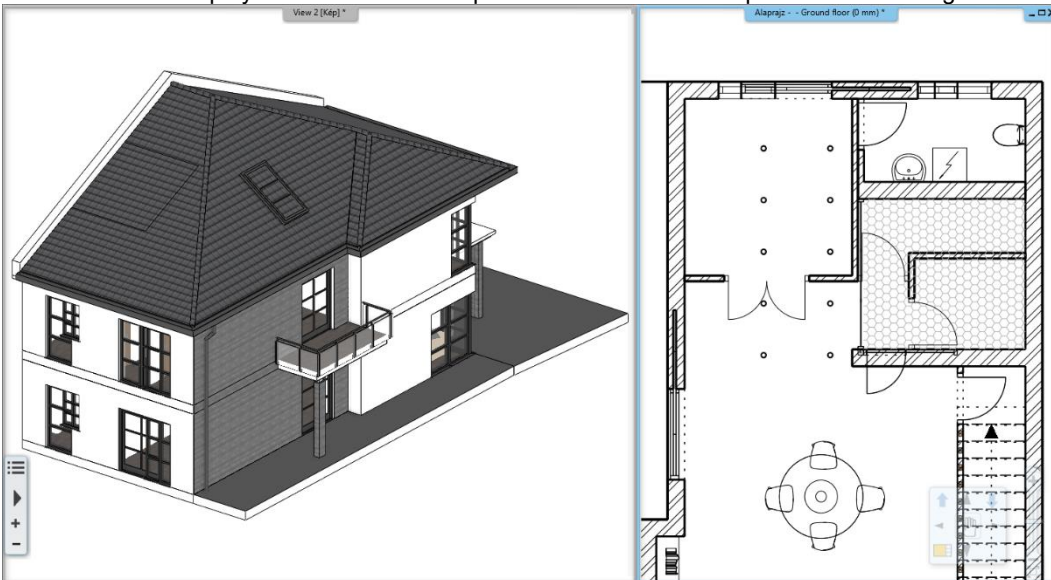

Wall parts in different phases

In the case of walls, it is also possible to mark only a certain part of the wall for demolition.

In this case, you can use the Edit / Cut with wall or Cut with line option in the wall context menu to cut the wall in half at the desired point, to have a remaining and a demolished part. After the successful cutting of the wall, a line in the wall indicates the boundary line of the two newly created wall parts. To remove the line, you can use the T connection command to connect the two new parts of the wall you just cut. One of the sections can then be moved to the appropriate phase.

2.3. Graphic overrides

Thanks to the graphic overrides, the representation of the different phases can be customized according to the needs of different disciplines. A graphic override is nothing more than specifying that an item with a given color, lineweight, and fill appears with the color, lineweight, and fill specified in the override, despite its original properties. This allows, for example, all elements of the demolition plan marked for demolition to appear automatically in red at the same time, without the need to change their appearance by any other manual method.

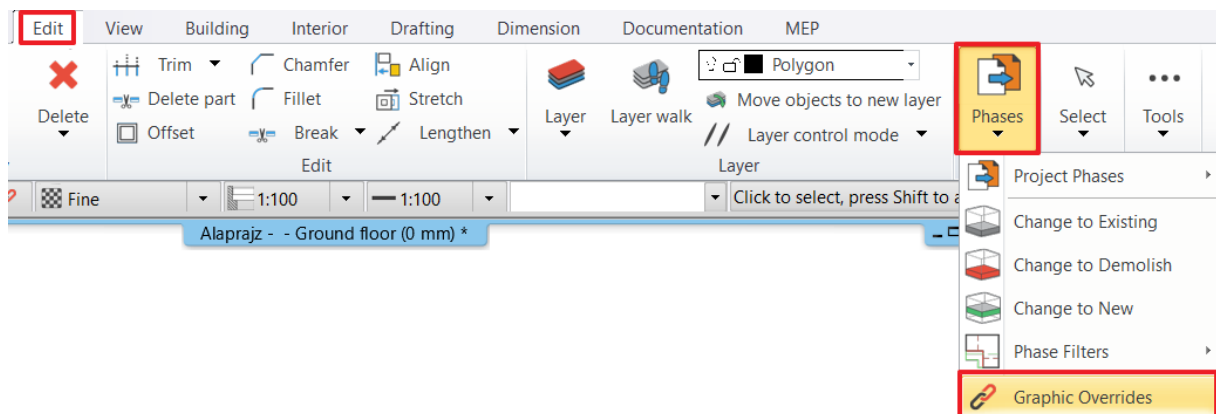

Graphic overrides can be determined in the phase filter for each phase separately. In the case of the "All" phase, which is used to display the phases on top of each other, it can be used as a clear, color-separated technical or even documentation drawing with the appropriate settings.

The appearance of each element in the phases can be fully customized: the colors, linetypes, lineweights, fills and the way they are displayed can also be customized.

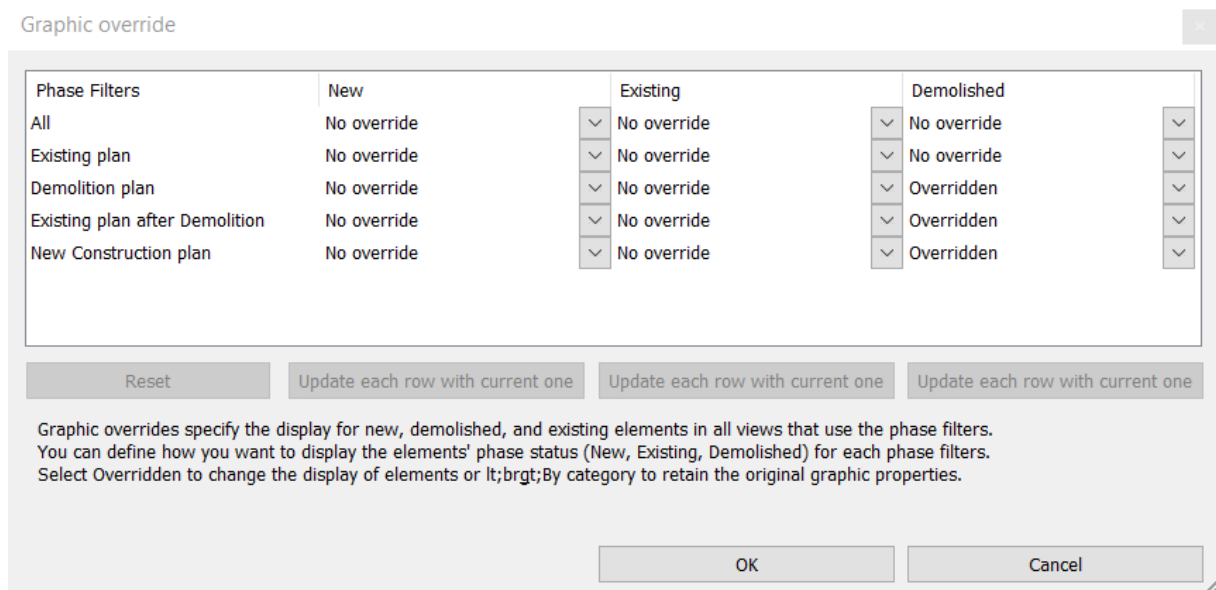

This feature allows you to deviate from the default settings, which may be required for either regional or industry reasons.

The feature can also be useful if you want to compare new elements, existing elements, and elements to be demolished in the plan. By specifying custom settings for the different phases, you can view the entire plan in both floor plan and 3D views by clicking All Phases.

2.4. Design phases on the sheets

The drawings placed on the layout sheet are displayed according to the current design phase. There is also a way to modify the design phase, so that regardless of the current drawing state, you can quickly compile a design sheet that shows different phases of the same drawing even side by side.

There are two ways to display the different phases on a design sheet:

- On the floor plan, set the appropriate phase, and after the program has loaded it, place the drawing on the sheet.
- Place the drawing on the sheet, and then in the drawing properties change the phase filter drop-down menu to the desired phase.

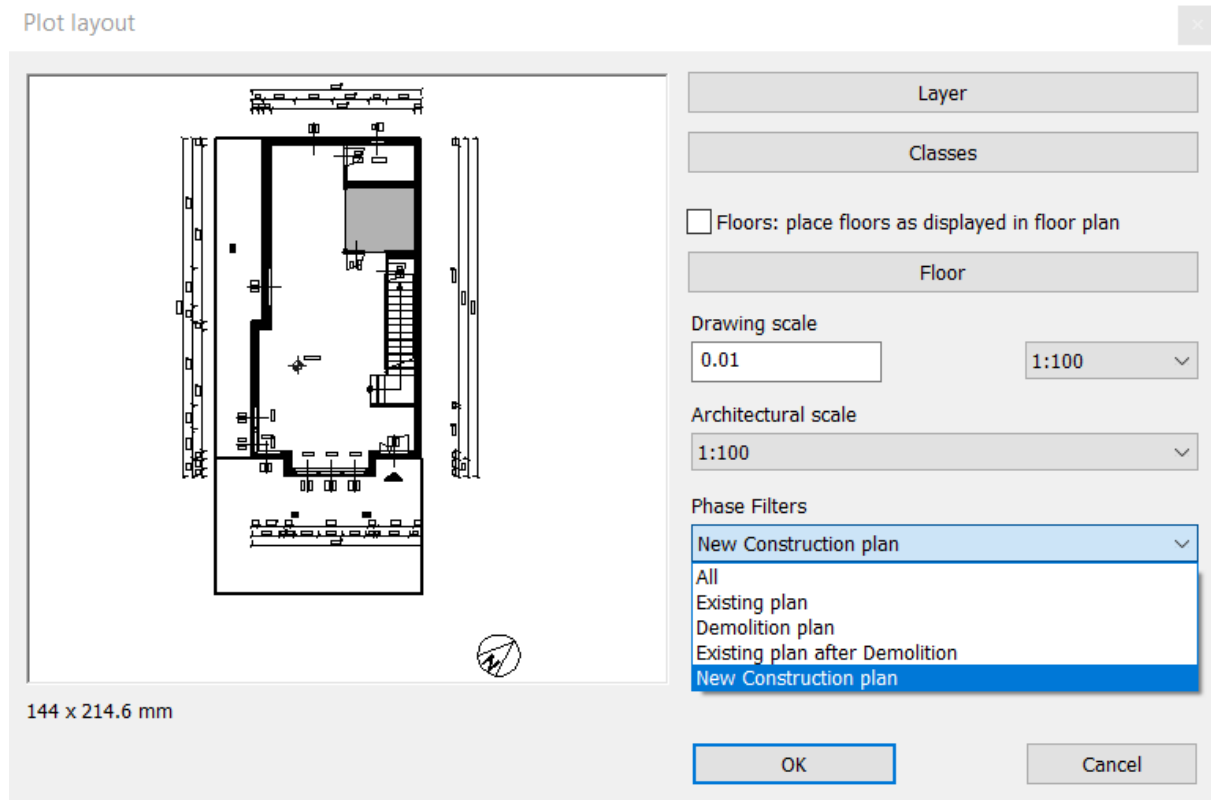

Changing the phase of the floor plan view does not affect the phases set in the print view, so you can change the phases in the drawings without interruption.

Drawing comparison

With this function it is possible for the program to compare different phases automatically.

- ❖ This requires the “Comparison between 2 design phases” option of the Ribbon bar / Documentation / Drawing Comparison / Drawing Comparison command, which you can select from the list after starting the command.

Based on the parameters that can be set in the comparison window, displays the program the corresponding buildings, levels, phases, colors and display modes.

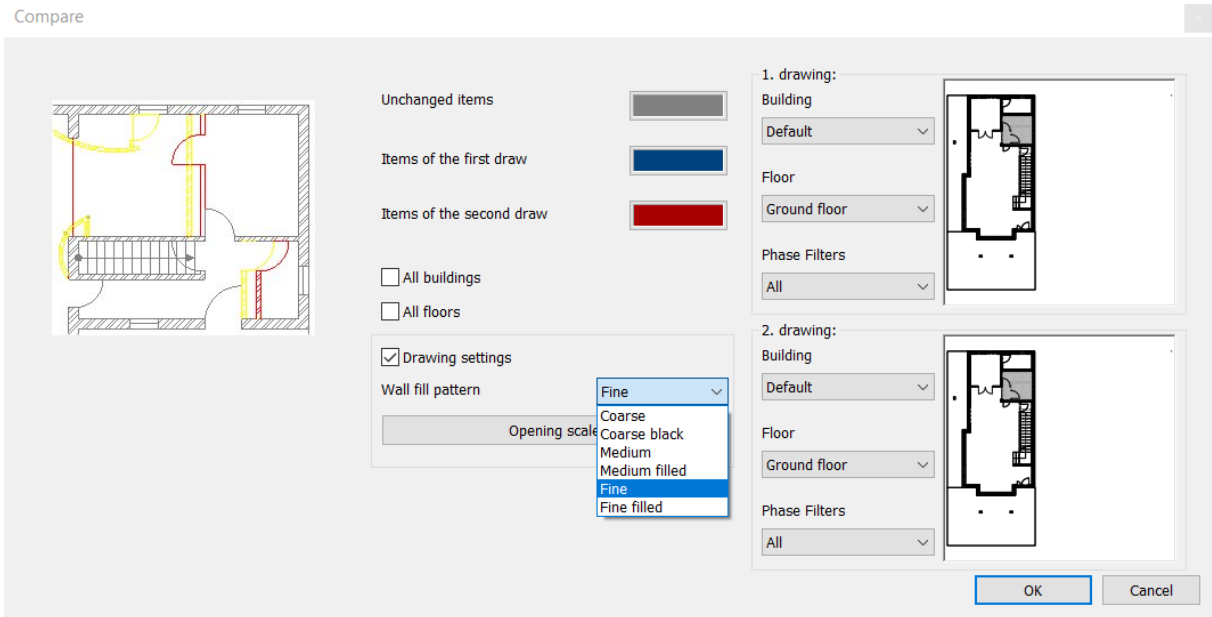

The resulting drawing is treated as a closed, non-editable, dynamically updatable group that you can place in the print view. If you change the plan, you can also update the comparison drawing with the "Update Comparison" command.

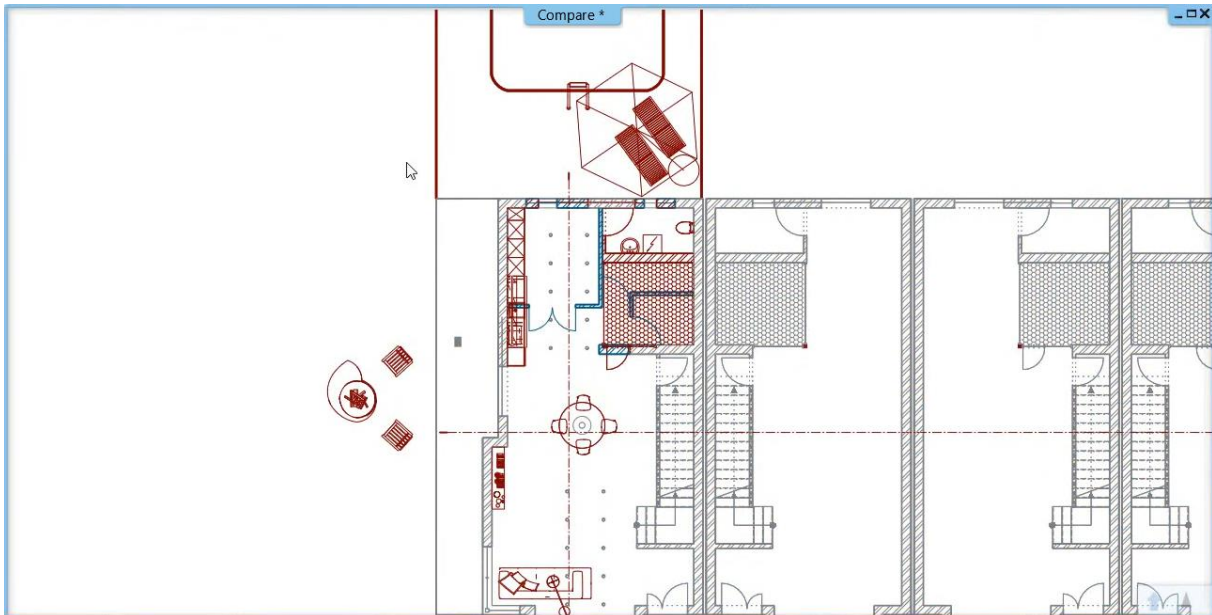

3. Workshop: Creating doors and windows

3. Workshop: Creating doors and windows

A wide variety of openings can be found in the Design Center under the Door and Window category, and these can be used in projects, such as Panelled doors.

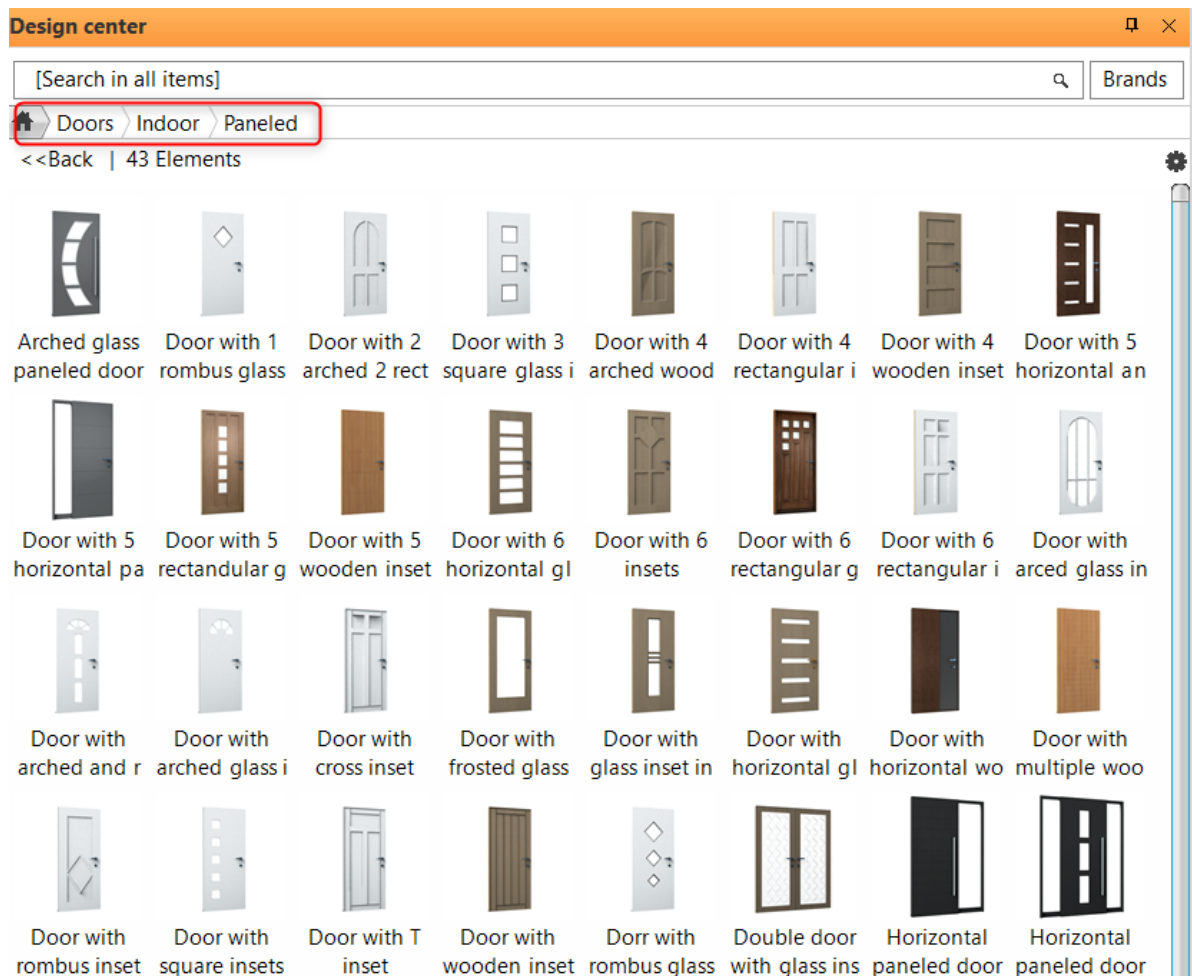

It might happen that the library does not contain a door/window type you need for the project. In this case, you have to design a new one.

There are several ways to create a new door or window:

1. Use an image to set the material of the door panel.
2. Convert a downloaded object to an opening
3. Using Door/Window Wizard

The disadvantage of using the 2nd method is that doors and windows cannot be opened in 3D.

- Open ...Documents\ARCHlineXP Draw\2020\Advanced_Course\3_Create_Openings\1_Reception_room_doors_start.pro file.

3.1. Use an image to set the material of the door panel

In the following example, we will use an image of a door panel.

Import the image of "Front_door_panel_2.png" from ...Documents\ARCHlineXP Draw\2020\Advanced_Course\3_Create_Openings\Image folder.

- Now save it as a material by using the *Local menu - Save- Save as material* command. Under properties, set the position to Stretch.
- Now drag and drop the new material on the door panel.

Materials

Front-door-panel_2



Details...

Parameters	Value
Texture	Front-door-panel_2.png
Position:	Stretch
Render styles	Wood

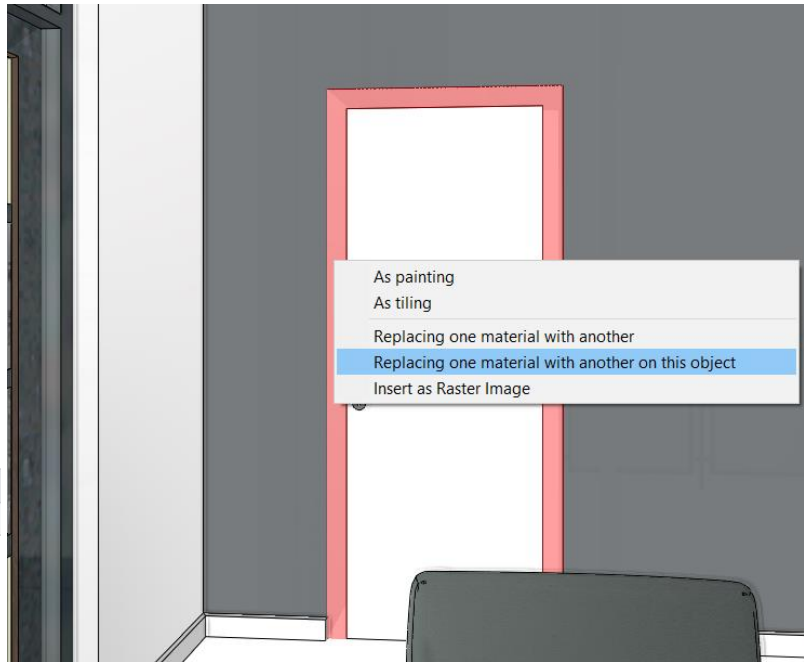

It is worth making a mirroring of the texture and the material from it. This way we can give the right material to the outer/inner leaf of the door. The material of the frame must also be adjusted: e.g. Beech-tree.

Material	Value
External frame material	Default material
Internal frame material	Default material
External leaf frame material	front-door-panel_1
Internal leaf frame material	front-door-panel_2

The final result:

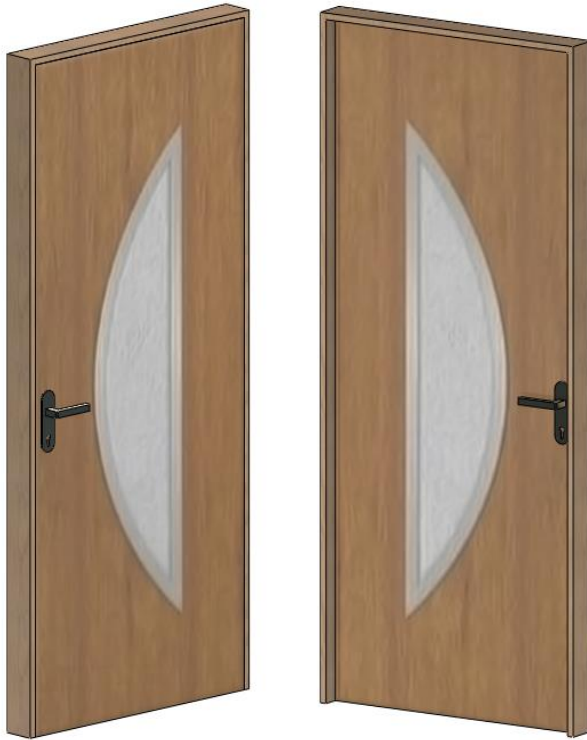

3.2. Convert a downloaded object to door/window

Now we are going to download a Sliding door from the Warehouse and convert it to a door.

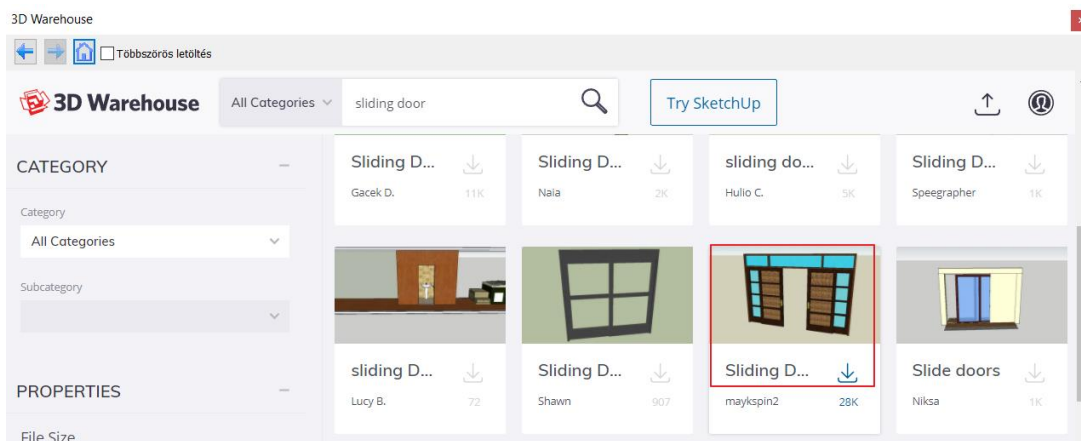

- You can also import the Double_Sliding_Door.skp file from Documents\ARCHlineXP Draw\2020\Advanced_Courses\3_Create_Openings\SKP folder.
- Place it on the floorplan as an object.
- First, you have to create the related 2D symbol and then save it as a group.

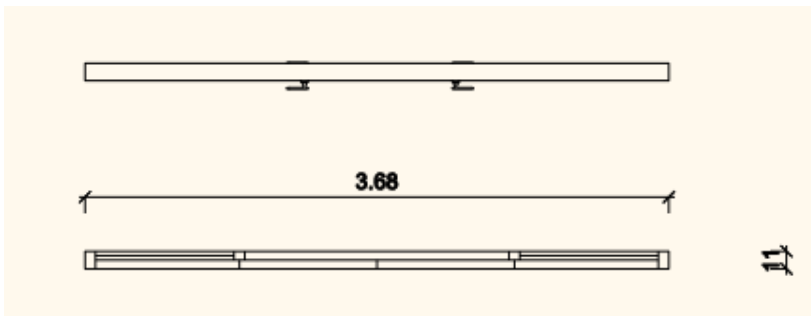

Now convert the object to door:

- Click on the *Local menu / Edit object / Convert object to door/window* command.

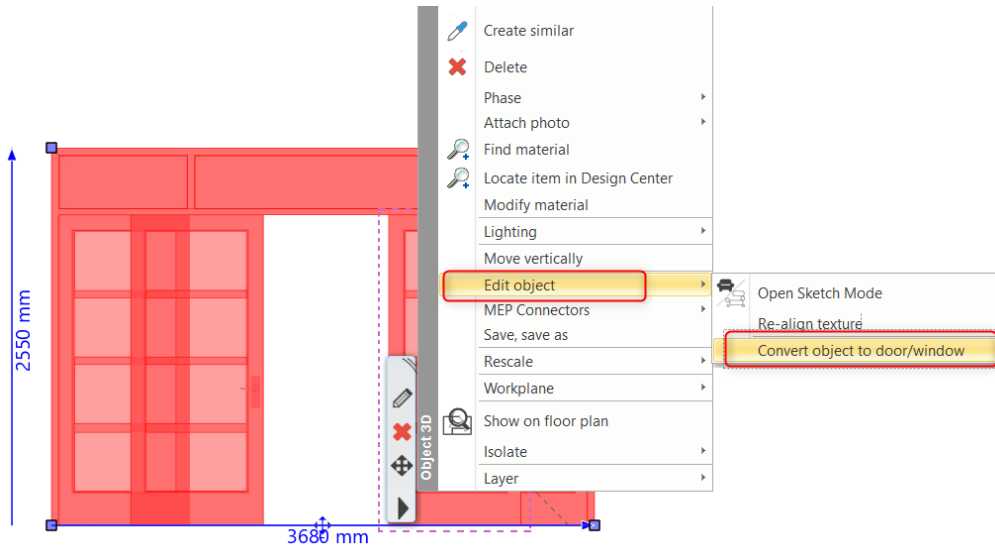

- Set the Opening type to Door.
- Now select from the library the previously created and saved 2D symbol.

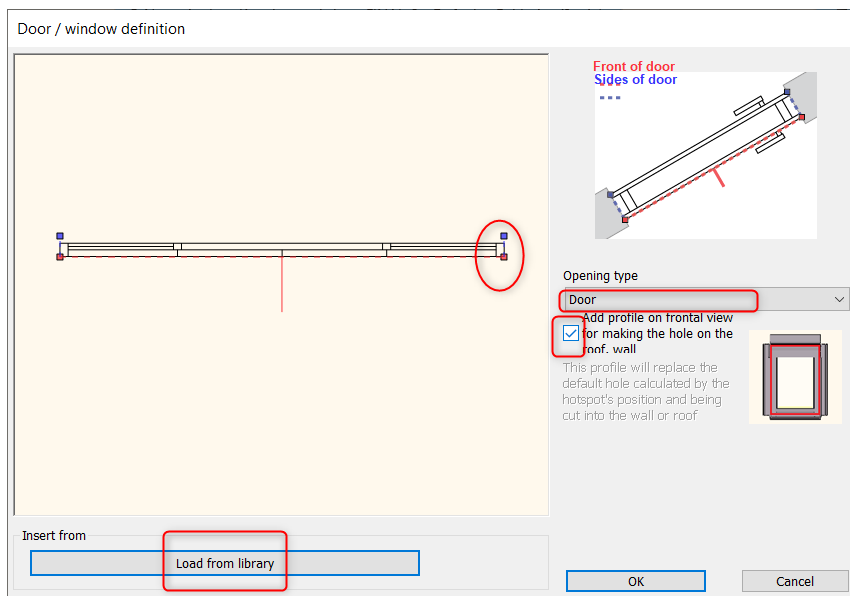

Make sure that the blue and red reference points are placed precisely on 2D symbol's the endpoints. Activate "Add profile on frontal view for making the hole on the roof or wall" option.

Click on OK, and now place the frontal profile of the door on the floorplan. Delete the unnecessary nodes to get a rectangle profile.

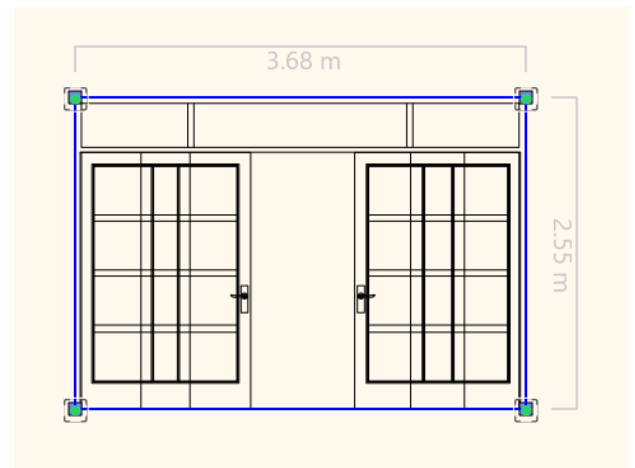
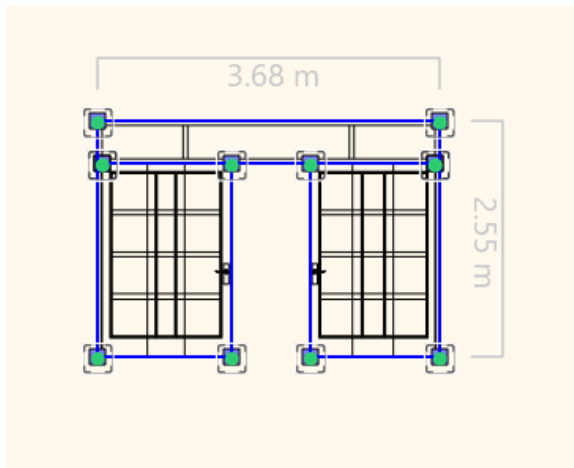

- Now place the new sliding on the wall and change its material:



3.3. Door/Window wizard

We selected the following examples:

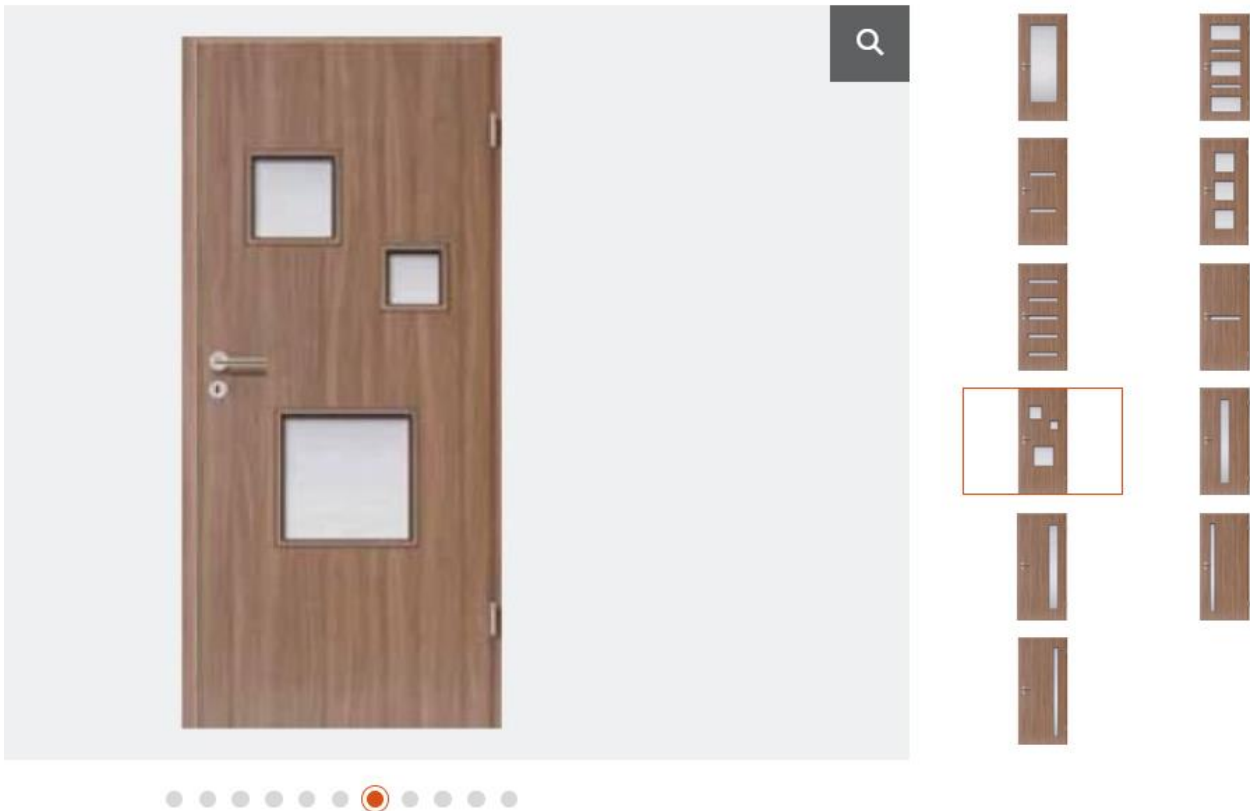

3.3.1. Door with insert on the right side

We will create the door is shown below; this will be the basic type we modify further.

- On the Ribbon menu, select **Building – Door- New Door- Door Wizard** Command. Now Door Wizard dialog window appears, here modify the following parameters:

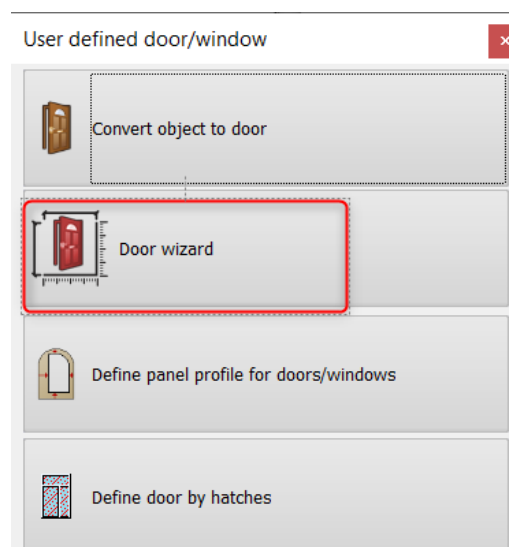

Main Parameters:

Door Wizard

Scheme	Full width	1 m
Main parameters	Full height	2.1 m

Representation

Door Wizard

Scheme	2D representation <input checked="" type="checkbox"/> Show threshold in 2D <input checked="" type="checkbox"/> Show frame profile bounding boxes on 2D symbol Opening direction symbol Arc
Main parameters	
Representation	
Frame	
Threshold	
Panel	
Geometry	3D representation <input type="checkbox"/> Show opening direction in 3D <input type="checkbox"/> Open panels in 3D

Frame

Door Wizard

Scheme	Side frame
Main parameters	<input checked="" type="checkbox"/> Enable frame
Representation	Frame 6 Frame 7 Frame 8 Frame 9 Rectangl e Simple
Frame	Profile width: 0.05 m Profile height: 0.1 m X offset: 0 m Y offset: 0 m <input type="checkbox"/> Adjust frame to wall thickness
Threshold	
Panel	
Geometry	
<input checked="" type="checkbox"/> Edge profile	
<input checked="" type="checkbox"/> Inset	
<input checked="" type="checkbox"/> Inset edge profile	
<input checked="" type="checkbox"/> Inner handle	

Threshold

Door Wizard

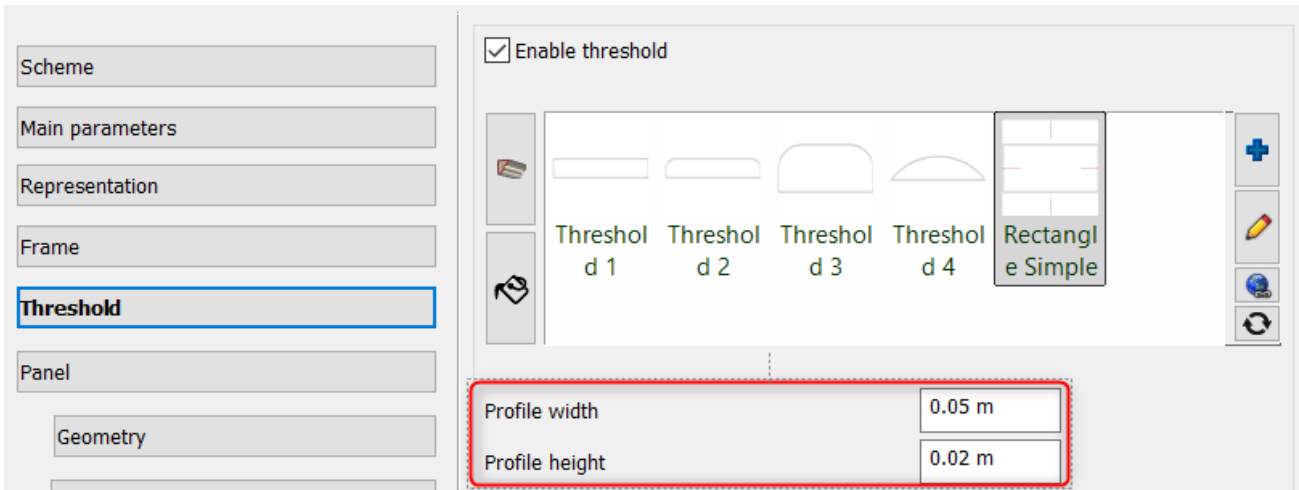

Panel

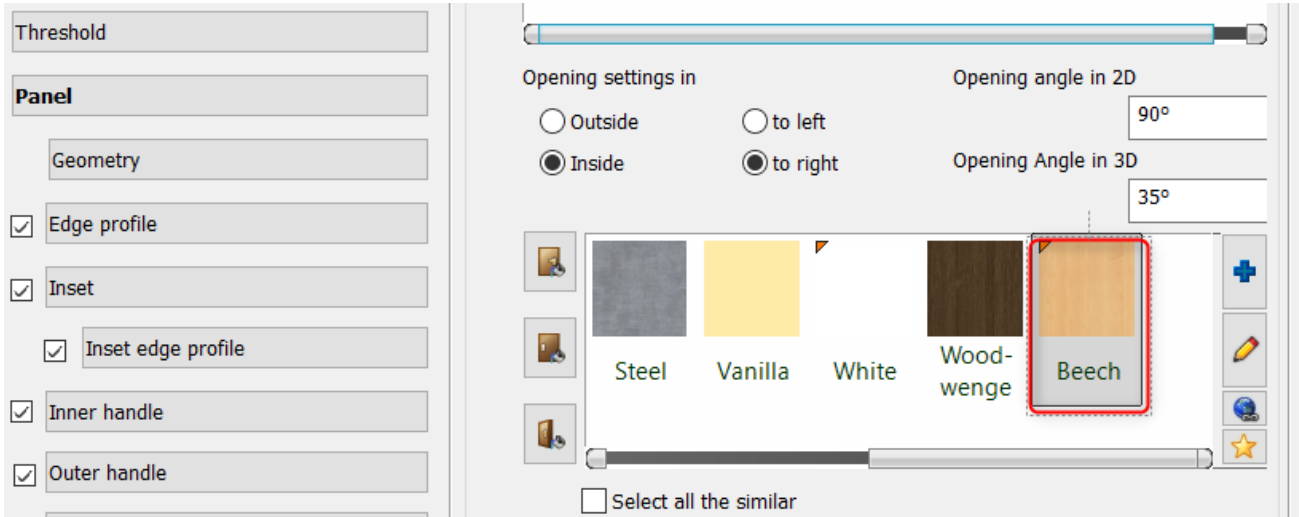

Panel - Geometry

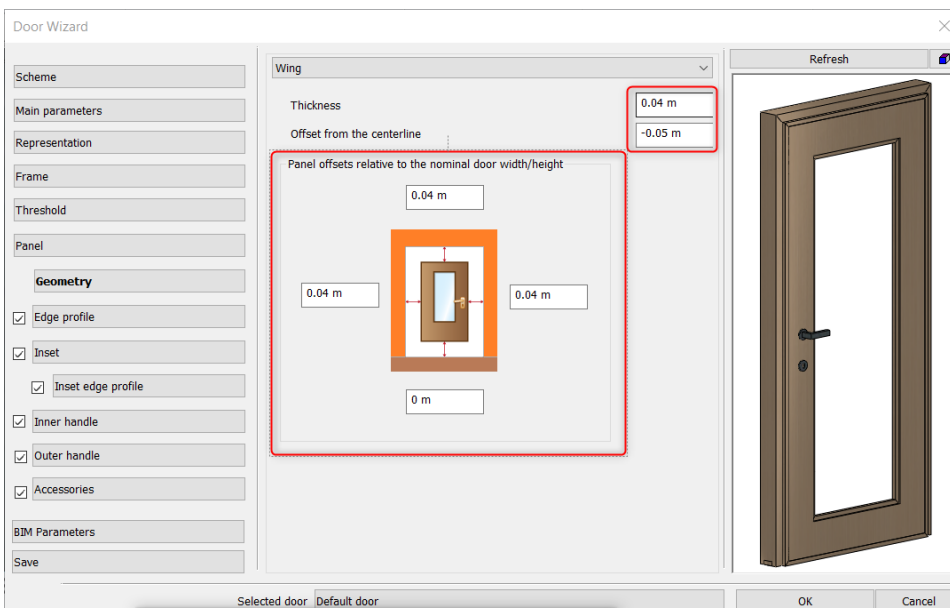

Panel - Edge profile

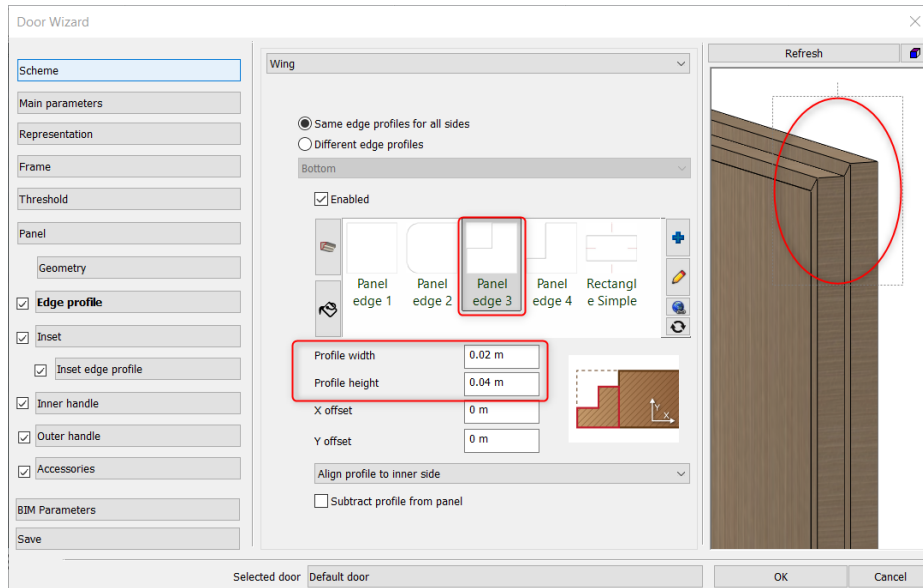

Betét

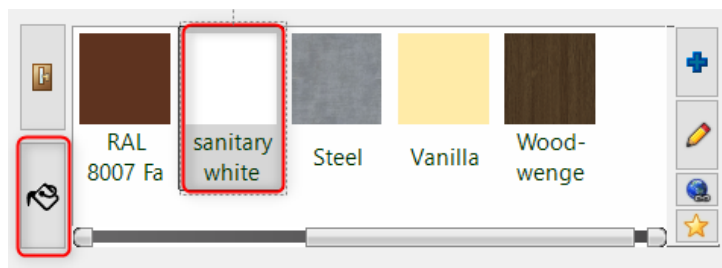
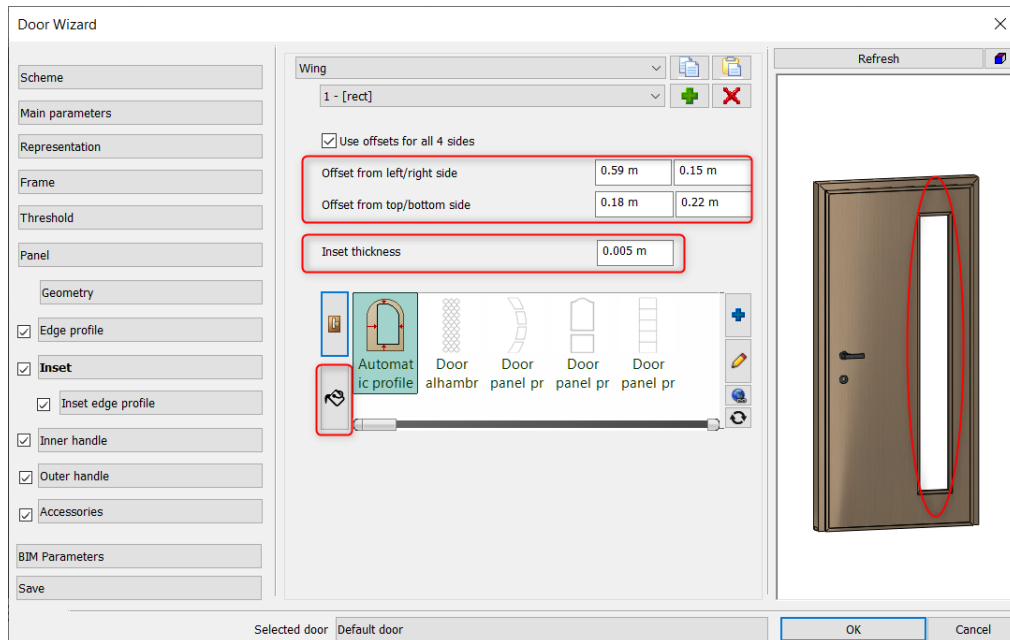

Panel- Inset edge profile

- Choose the *Panel inset edge 5* profile

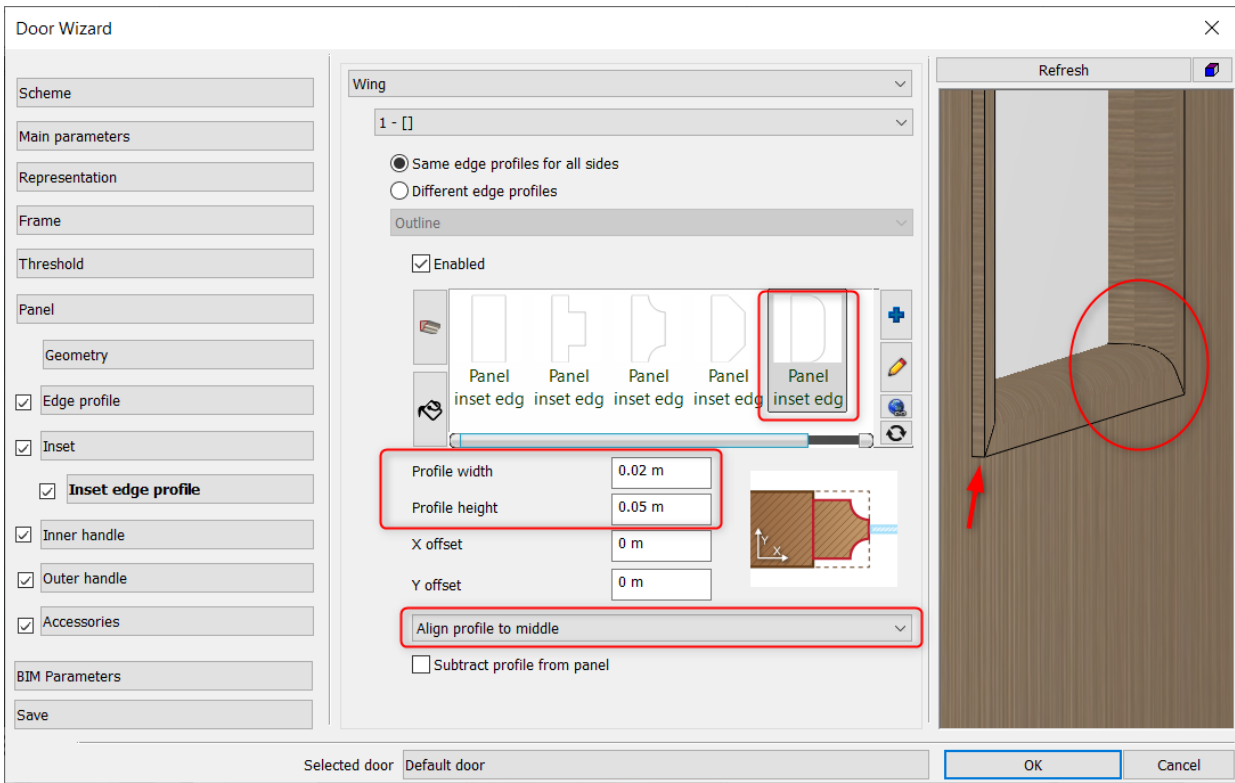

Inner handle

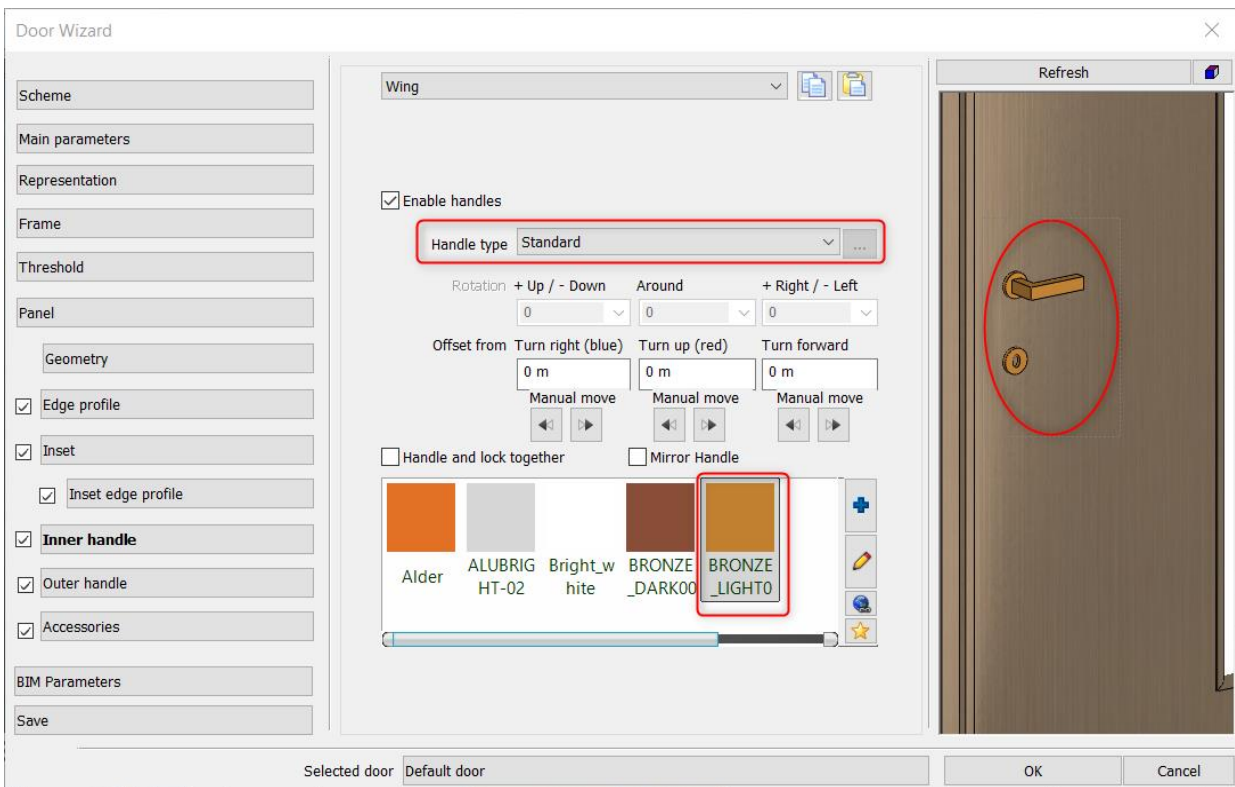

Outer handle

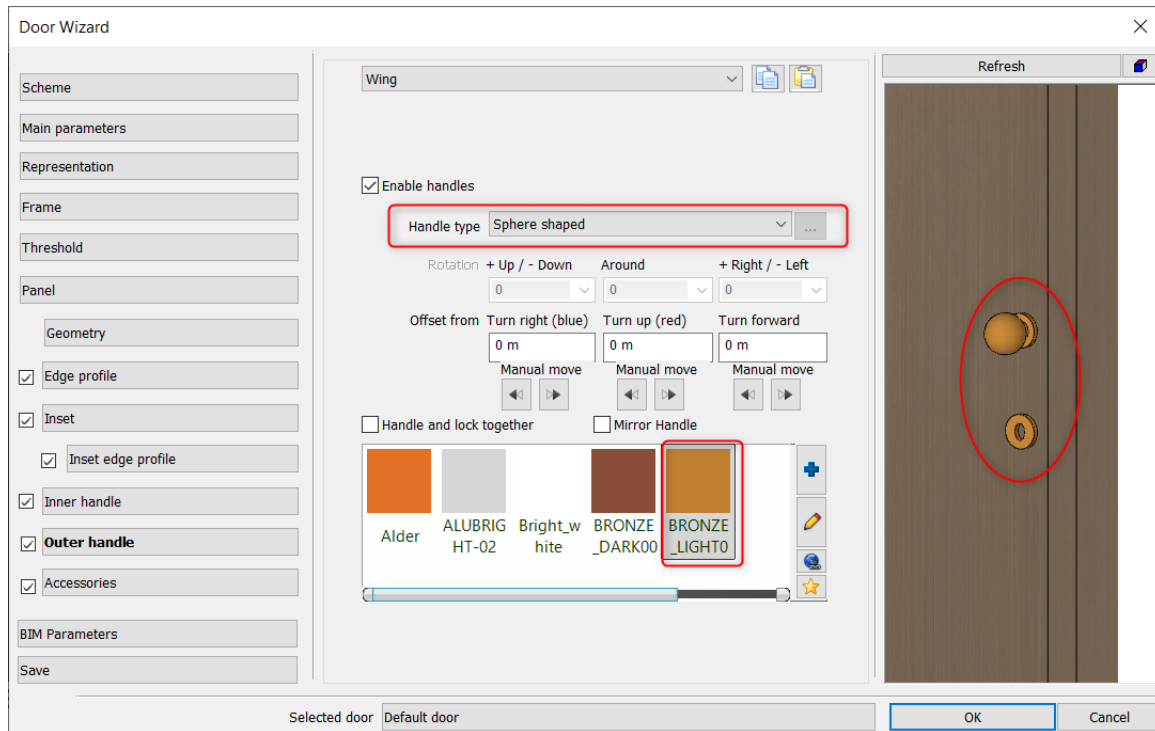

Save

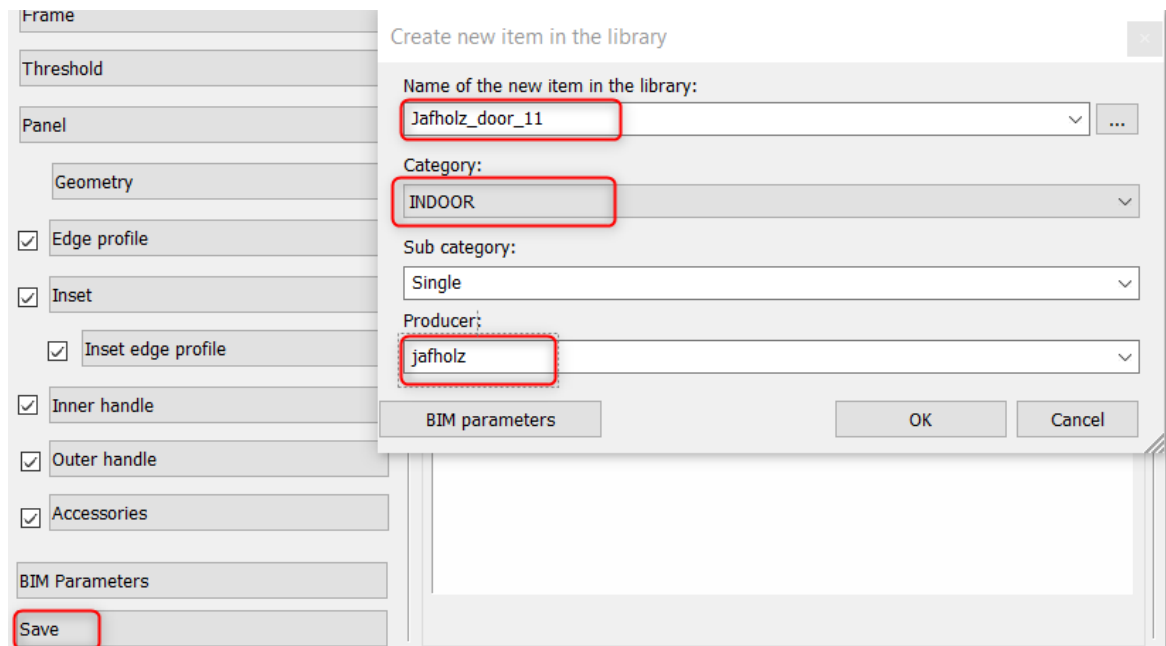

- Save the door as Jafholz_door_11.
- Finally, place it on the wall.

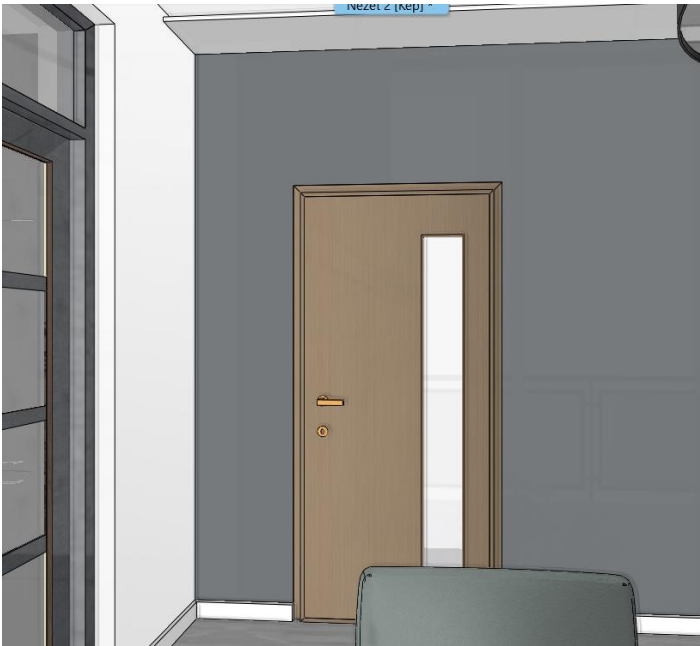

3.3.2. Door with an inset on the middle

Now we are going to modify the previously created door.

Open Door Wizard.

Select Jafholz_door_11 from the library.



Inset

Modify the position of the inset.

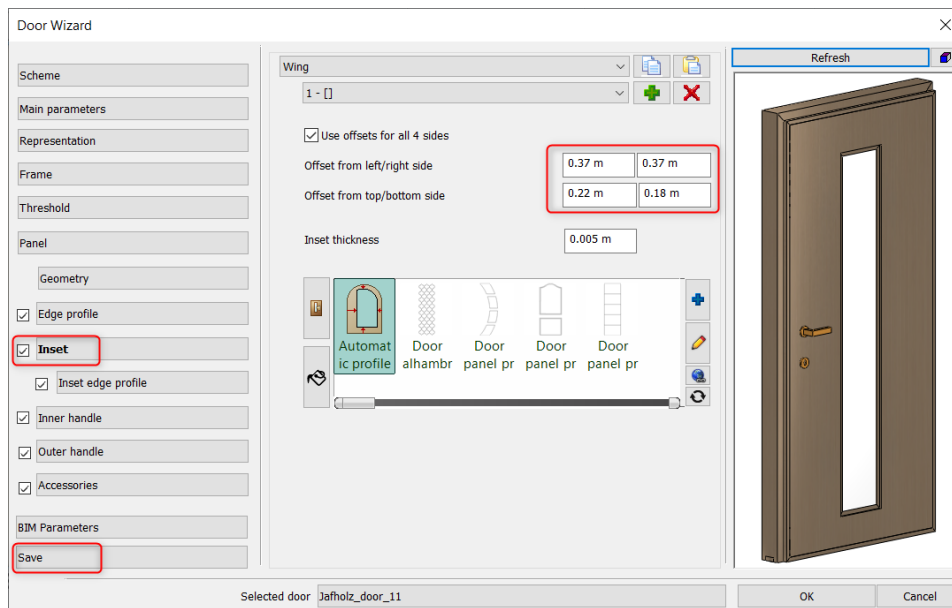

- Finally, save the door under a new name: Jafholz_door_12.



3.3.3. Door with three different insets

There are insets on the next door in different sizes. These are defined by multiple profiles that we first we create and save.

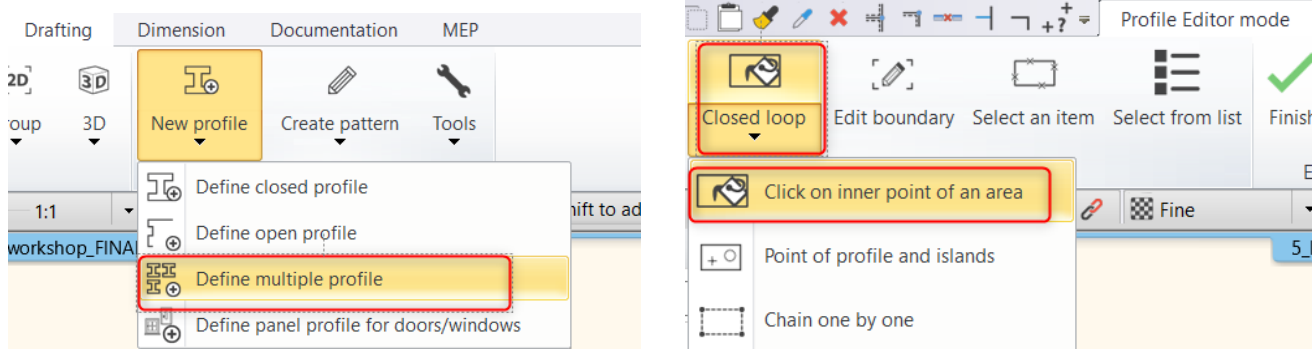
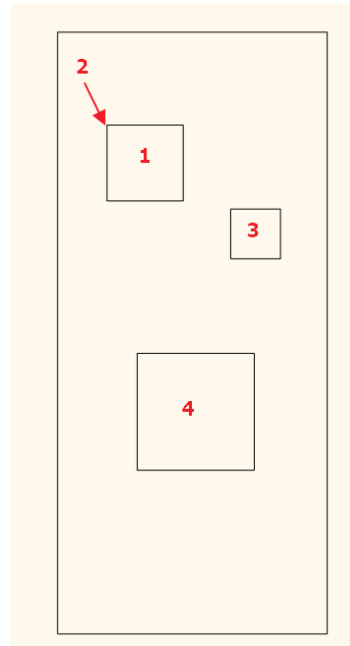

- On the Ribbon menu, select **New profile- Define multiple profile** command.
- Define the first square by using the “Clicking on inner point of area” command. (1)
- Then, set its reference point. (2)
- Define the profiles of the remaining squares. Finally, press Enter.
- Now save the profile under a new name.

Open the first door we created and modify the inset.

- Open Door Wizard.
- Select Jafholz_door_11.

Inset

- Select the new inset profile from the library.
- The modify the position of the profile: Offset from left: 0,17m, offset from right: 0,16m, offset from top 0,32m, and offset from bottom side: 0,56m.

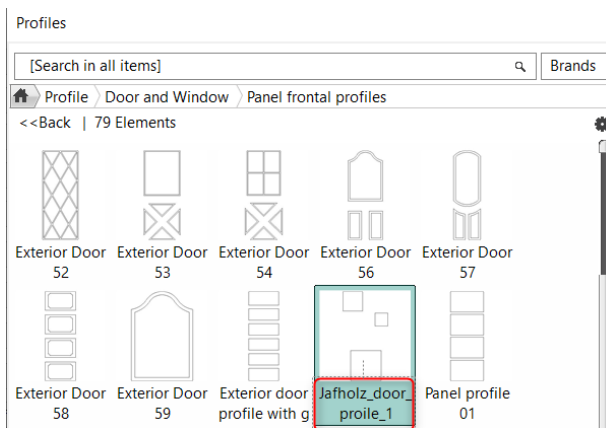
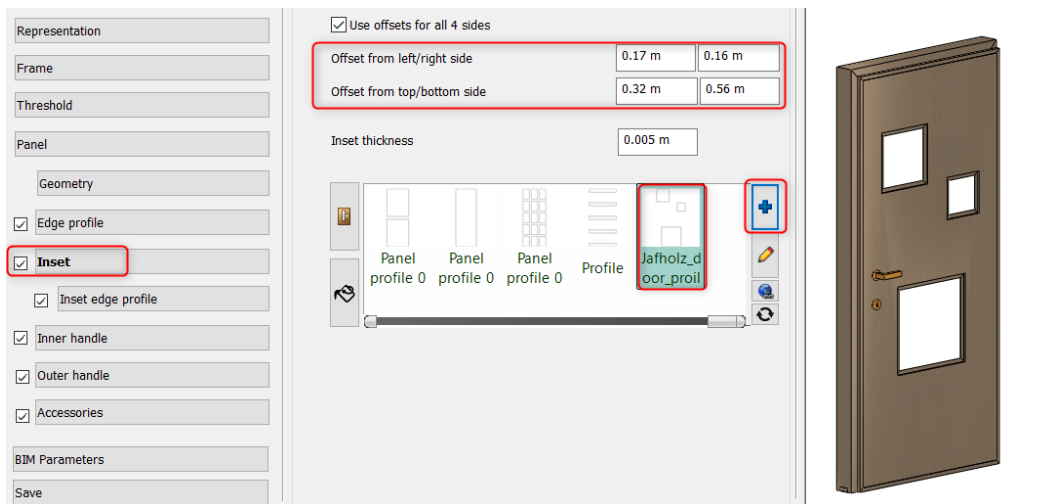

- Finally, save the door under a new name: *Jafholz_door_13*.



3.3.4. Door with five different insets

This door has five rectangle insets. We create the door inset profile by defining the multiple profile. Let's create a new profile and save it.

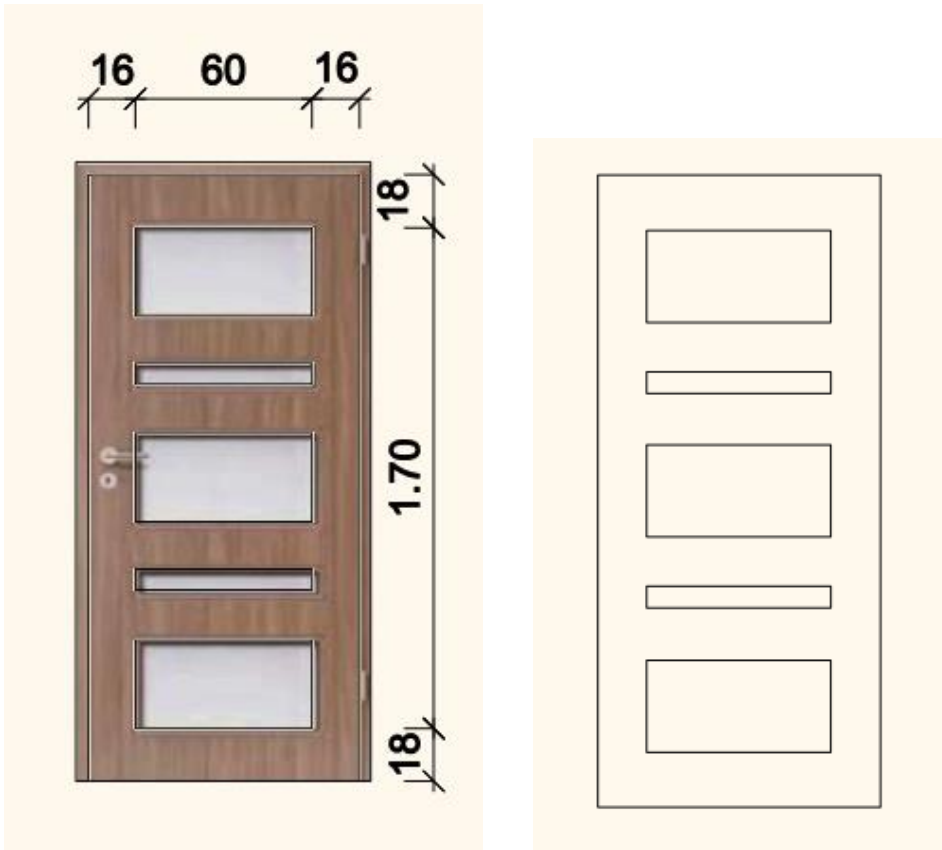

Open the previously created door and modify the inset.

- Open Door Wizard.

Inset

- Select the new profile from the library.
- Change the position. The offset from left side: 0,16m, offset from right : 0,16m, offset from top: 0,18m and offset from bottom: 0,18m.

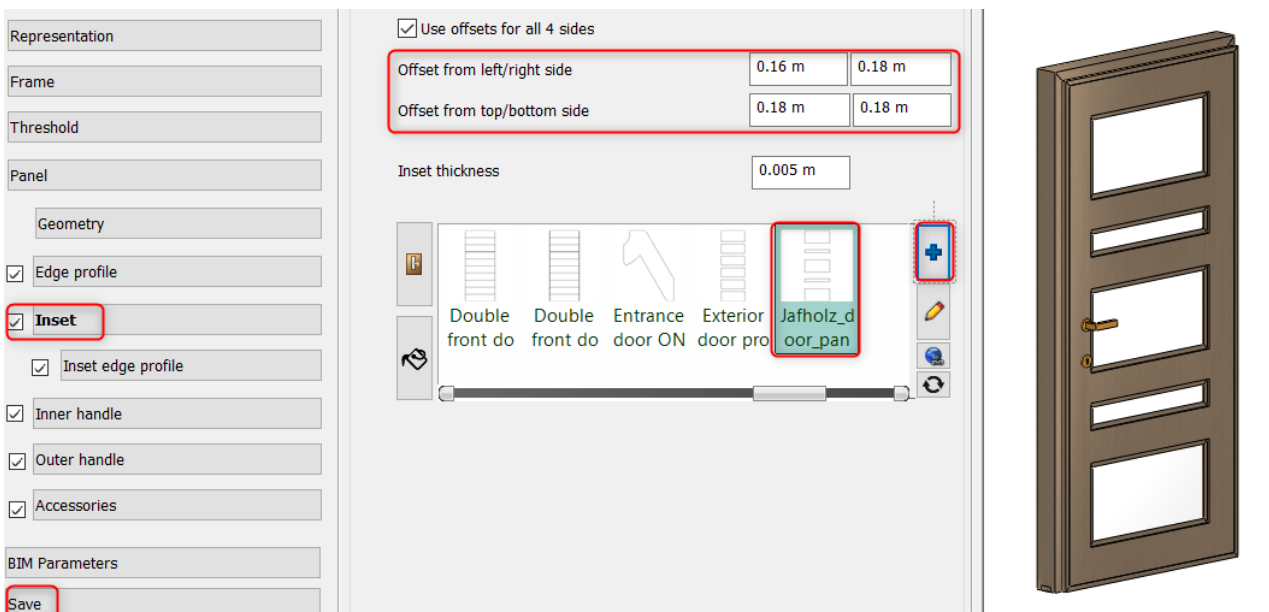

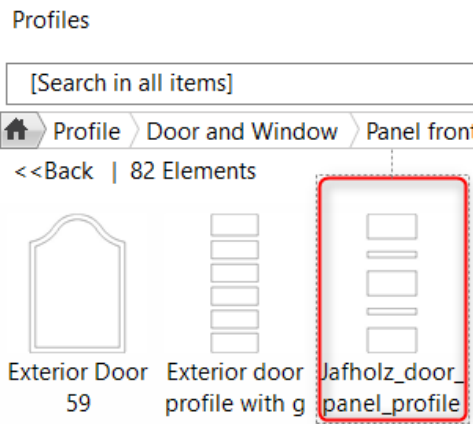

- Finally save the door under new name: *Jafholz_door_14*



3.3.5. Door with decorative strips

This door has two decorative strips. We use the previous method here as well. We create the door inset profile by defining the multiple profile. Let's create the a profile and save it.



Use the previously created door and modify the inset properties.

- Open Door Wizard.

Inset

- Select the new profile from the library.
- Set the new position: Offset from left: 0,7 m; Offset from right: 0,14 m; Offset from top 0,001 m and Offset from bottom side: 0,001 m.
- The inset thickness is 0,03 m.
- Set the material to Bronze.
- Switch off the Edge profile and Inset edge profile.

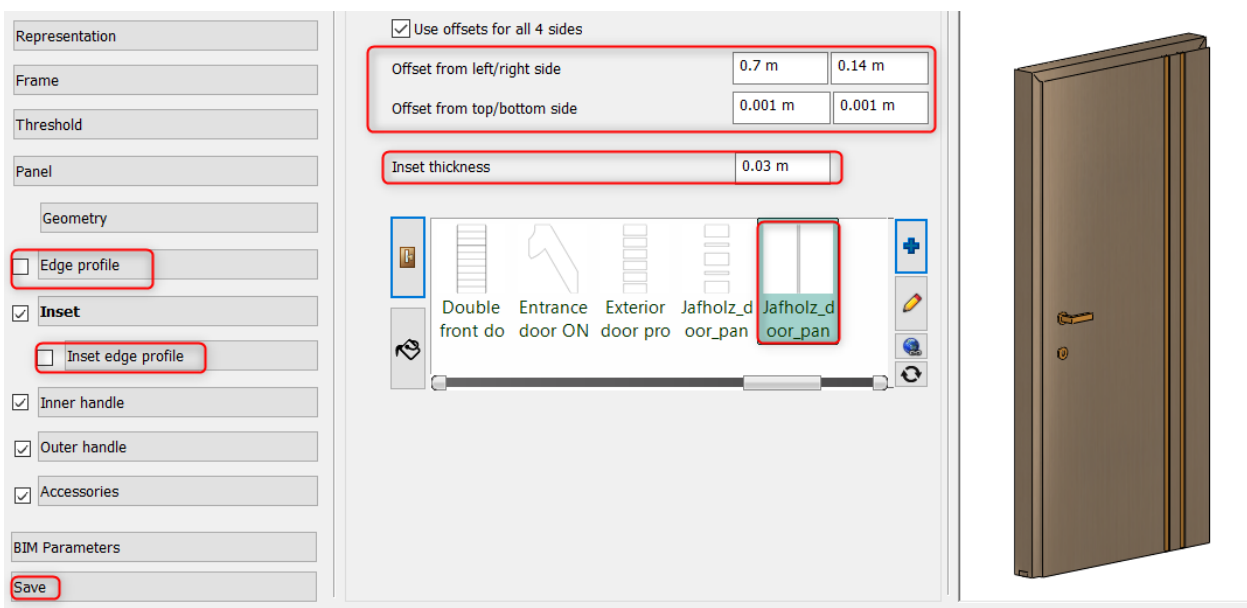

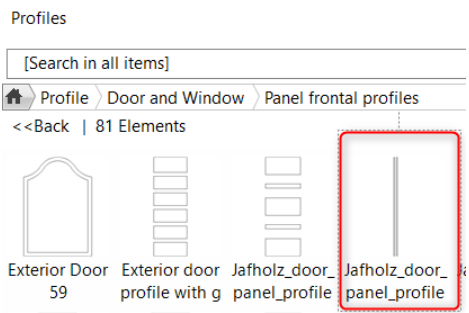

- Finally, save the door under a new name: *Jafholz_door_15*

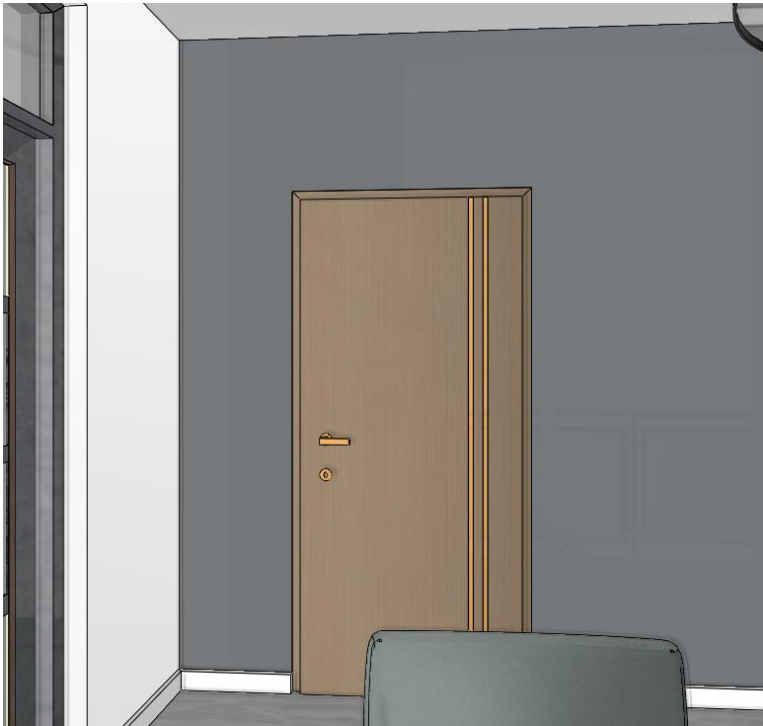

4. Workshop: Teamwork

4. Workshop: Teamwork

The Teamwork tools allow working on the same project with your colleagues together simultaneously. Every part of your project updates automatically, so that the plan and the documentation are one coherent unit through the lifecycle of it.

Teamwork works over a local area network or using a file server when all connecting users have access to the same physical teamwork file over the network.

Cloud-based file sharing services are NOT recommended as those services do not grant access to the same physical file but only a local copy of it. This way it is not guaranteed that all users work on the same state of the teamwork which may lead to synchronization / permission issues and information loss.

4.1. Basic concepts

Working area

Working area organizes all items that a team member may make changes to under a logical unit. New items are automatically placed on the active layout owned by the team member.

Master working area

The master working area collects all the common part of the team work such as drawings, building parts, floors, layers, views and geolocation. Because of its special role during the team workflow it is password protected. A team member who enters the mater working area also has administrative rights for the time being.

Team member

A user identity consisting of a name and a(n optional) password, granting access to the teamwork project to make modifications on the works space that is owned by the team member.

Administrator

A team member who owns the master working area. The administrator can modify the common parts of the team project and also has the right to create new working areas and add / remove team members.

Central model / Central project

The central model is the result of the work of the team members, automatically merged into a central project file. It continuously evolves as team members publish changes. All team members working online can see and work on the latest status when they open the project file or when they refresh the project.

Local version

All local changes created on the base of the central model. When saving the project all local changes are aotumatically published to the central model.

Main principles

- ❖ Teamwork allows simultaneous access to a shared work through the use of a central model.
- ❖ The central model has to be saved on a network drive to which all team members have access.
- ❖ Master working area is privileged to define team project fundamentals (Storey structure, layers, geo-location and initial state of the project).
- ❖ Team members may create or own many working areas. One team member can edit only one active working area and may have multiple other available as editable. An ownership over a working area automatically terminates when the team project is closed by the team member.
- ❖ All users work locally on different working areas. Every user can manage one working area in active state to which new elements are added. All other working areas are there for reference purposes.
- ❖ An ownership of a working area can be terminated by the team member at any time. If an item belonging to another working are must be edited, the user needs to ask from the owner to grant access to the working area by releasing it. . After released the working area may be owned by any other team member.
- ❖ Only a team member with administrative privileges can take working areas from other team members and erase or merge working areas.
- ❖ Graphic Override enabled to provide different output of the view (color, line types, line weight, half-tone, and hatch pattern).
- ❖ Saving the project also means synchronization with the central model, publishing changes and making it available to all other team members.
- ❖ If a team member would like to go on-site or by any other means wishes to leave and take the current status of the changes the team member may turn the project to offline mode on that computer. When going back to online mode all changes are automatically published.

- ❖ Reaching specific mile-stones or wanting to create an archive copy the team project can be converted into a single user (regular) project. The conversion creates a copy of the content and the single user copy of the project is no longer connected to the teamwork.

4.2. Setting up a team project

You can convert any regular project into a team project by following these steps:

- ❖ Open an existing project.
- ❖ Convert the project into a team project using the “File / Teamwork / New project” command. Specify a file name and location for the central model on a network drive to which all team members (users) have access.
- ❖ Add new team members by defining the name and an optional password for login.
The following image shows the User administration dialog, adding users.

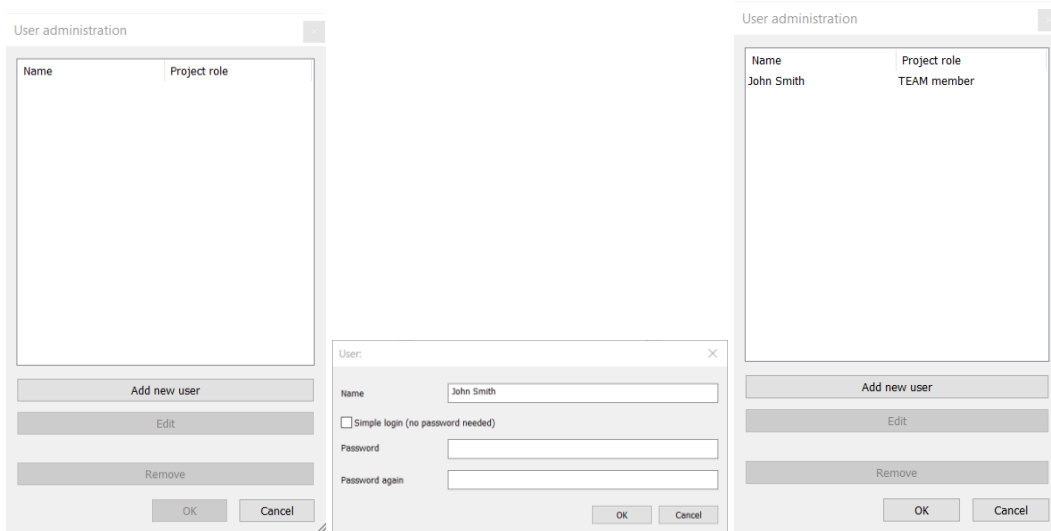

- ❖ Login by choosing one of the identities previously defined.

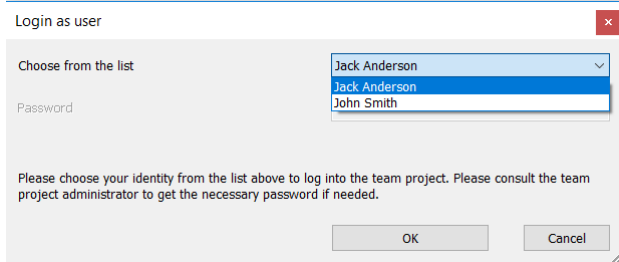

- ❖ Create the Master working area. Master working area is the only working area where password is required to enter. This is the common part of the team project which can only be modified later by a team member who knows the password to it.

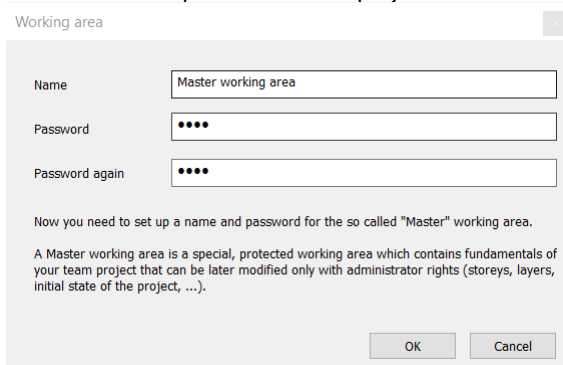

- ❖ Create additional working areas. These provide simultaneous access to the shared model for the other users. Work spaces can be named after work types, identities or other ideas. One working area can be owned later only by one team member this protects the integrity of the team member's work.

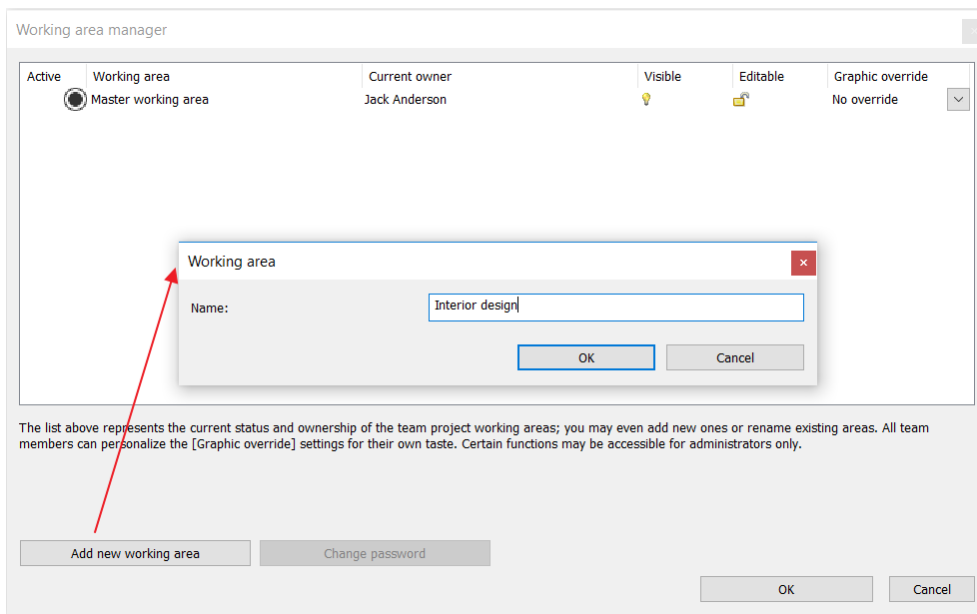

- ❖ Save the project.
- ❖ Close the project. Closing the project releases all working areas for other users. Team members can login choosing one of the identities previously defined and begin to work on Team projects.

4.3. Working in a team

You can work in a team following these steps:

- ❖ Open the central team project file.
- ❖ Login with a name (and optional password).
- ❖ Choose one or more working areas and designate the active one.
- ❖ Create new items and/or modify and remove existing ones on the working areas currently owned.
- ❖ Save the project to publish all local changes to the team.
- ❖ Exit teamwork by closing the team project.

4.4. Refreshing the team project

The team project is automatically refreshed when the central project is opened or on-demand using the “Refresh project” command.

Turning the local project to offline mode the team project cannot be refreshed until the project is set back to online mode again.

4.5. Working area administration – managing working areas

The working area is a collection of elements handled by a team member, eg. walls, windows, doors, stairs, etc.

Only one user can edit one working area at a given time. All users can view the working areas owned by other users, but they cannot make changes on it.

The Working area manager provides functionality to create or change working areas.

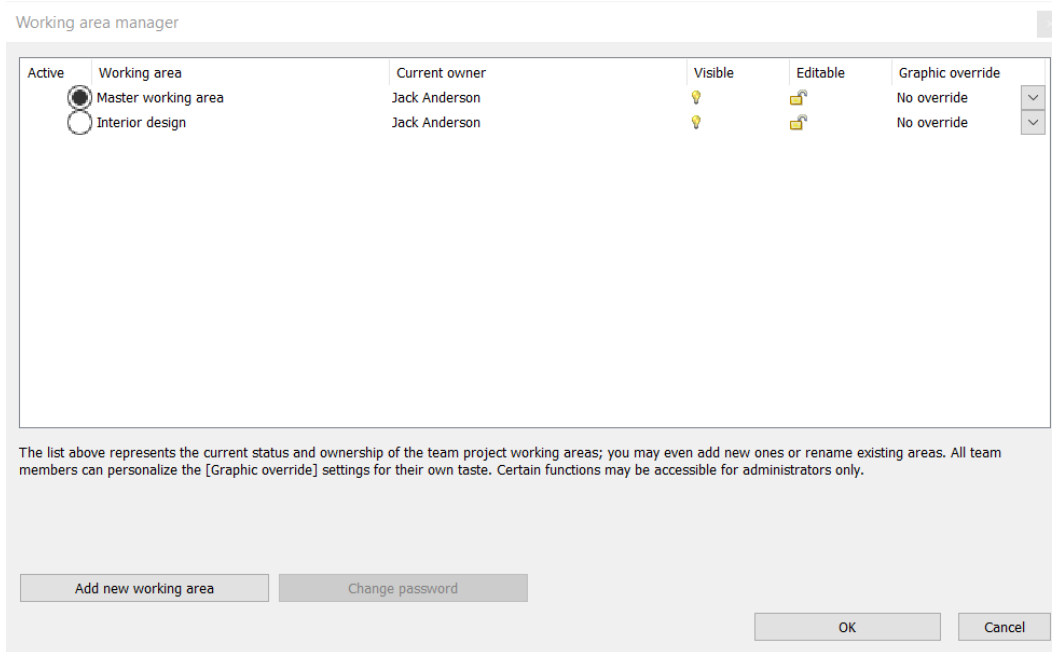

The Working area manager dialog provides the following information:

Active	Designates the working area to which new elements are added. You can relocate the indicator when multiple working areas are owned.
Working Area	Indicates the name of the working area. Click inside the name field to rename it.
Current owner	Indicates the current owner of the working area.
Visible	You can enable or disable the visibility of a working area. You can hide unwanted working areas to increase efficiency for your work.
Editable	By default all working areas are locked for editing. Choose one or more working areas you want to edit. When you take over more than one working areas you can activate one working area to which new elements are added. Working areas currently owned by other team members cannot be taken over for editing but they are still visible as reference drawings by default. Should all the working areas be occupied by other team members already you can still login as a passive visitor in READ-ONLY mode.
Graphic Override	Use the Graphic override option when you would like to colour-code representation of different working areas for better understanding. You can define colour, half-tone, line type, line weight and hatch pattern for override.

4.6. Change active working area on the View Control Bar

The View Control Bar always displays the active working area. To change the active working area, click on the drop-down list and select another one. You can only choose working areas currently owned and editable.

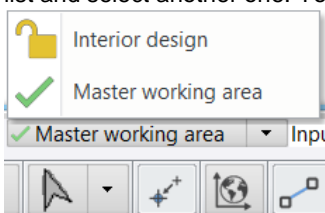

The active working area drop-down provides the same functionality as the "File / Teamwork / Working Area Administration" dialog.

4.7. Reassign elements to a different working area

A team member can reassign elements on one working area to another working area by using the „Reassign elements to a different working area” command and selecting the items.

At specific administrative steps (such as deleting a working area) it is also possible to reassign items belonging to a working area.

4.8. Work offsite or offline

Changing to OFFLINE mode is useful when you are not connected to the network to save your changes.

Working in OFFLINE mode you can work on the project and make changes on your editable working areas far from the team, with no network connection.

Project changes are saved on your hard drive each time you modify and resave the project.

To share changes with the team members switch back to ONLINE mode when you can do that and save the project file.

Use the “File / Teamwork / Creating a Local Copy for OFFLINE mode” command to go offline.

Note: all changes made on this project are not available for other team members until you switch back to ONLINE mode and save the project again.

4.9. Convert Team project into single-user project

Reaching specific mile-stones or wanting to create an archive copy the team project can be converted into a single user (regular) project. The conversion creates a copy of the content and the single user copy of the project is no longer connected to the teamwork.

- Use the “File / Teamwork / Administrative tools / Convert Team project to single-user project” command.
- Save the project.
- Close the project.
- Open the project again. From now on you can work in single user mode.

5. Workshop: Lighting plan

5. Workshop: Lighting plan

Lighting plan shows how electrical items and wires are connected, where lights, light switches, socket outlets and appliances locate. Therefore, it means to create several types of plans. These mostly depend on the project, designer, and expectations.

In this workshop, we demonstrate through an example of how you can create the following type of electrical plans:

1. **Wiring layout**
 2. **Socket layout**
 3. **Switches layout**
 4. **Lamp layout**
- Open ...Documents\ARCHlineXP Draw\2020\Advanced_Course\5_Lighting_plan\Lighting_Plan_Start.pro file. Save it under a new name.

5.1. Wiring layout

The task is to bind switches with luminaires as the sample illustrates below.

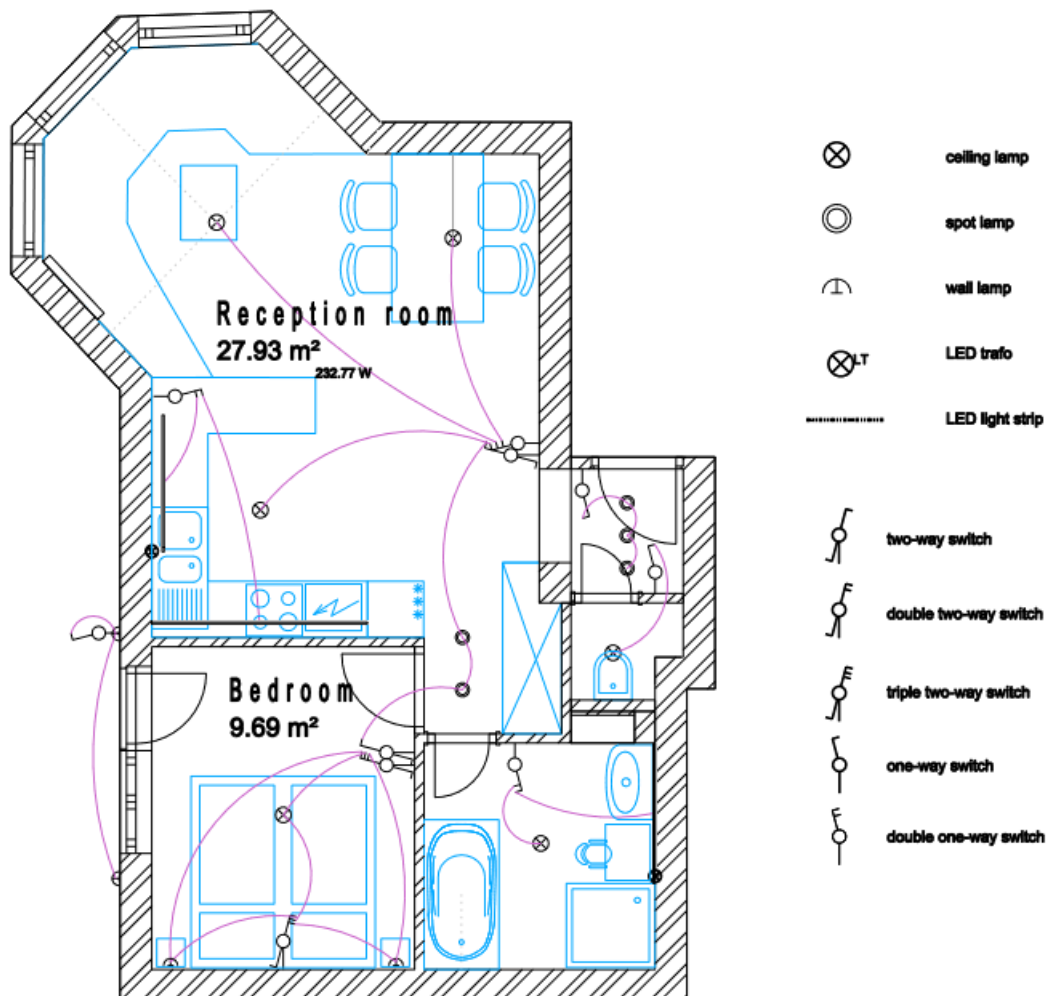

On the layout, we use symbols for representing the electrical items, which makes possible the unified appearance on the floorplan.

The method is the following to create a wiring layout:

- ❖ Define the type of lighting fixture: ceiling, wall, desk, pendant or spot lamp
- ❖ Define settings
- ❖ Switching to a lighting fixture symbolic representation

- ❖ Assigning switches to luminaires
- ❖ Check the switches and lamp statuses: free or fully connected switches; free or connected lamps.
- ❖ Finally, the program provides information about the power consumption to be built in a room.

In the project, select the **Wiring layout** from layer variations. We start from here:

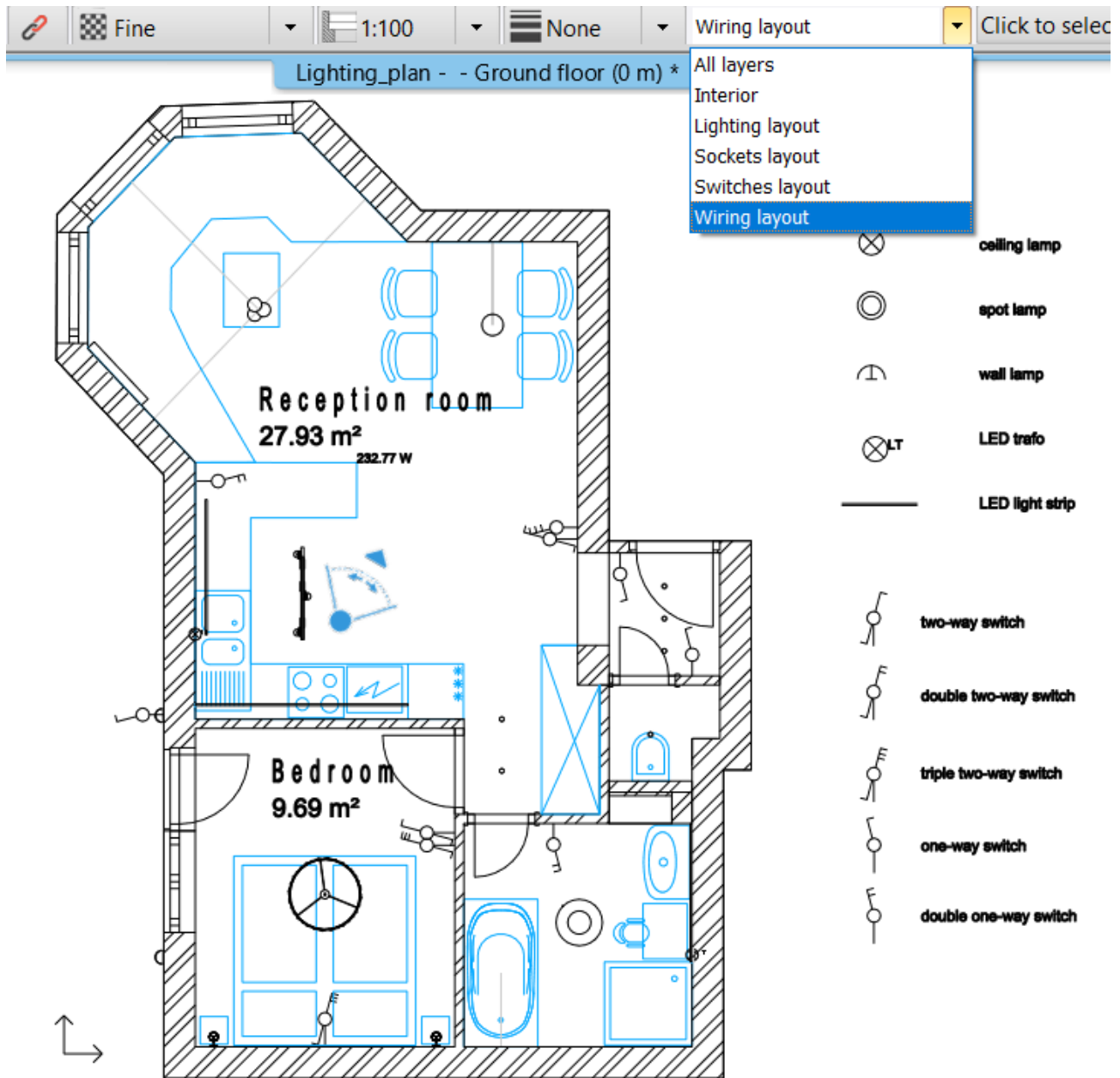

We are going to use Lighting plan commands these can be found under the Ribbon menu / Interior tool groups.

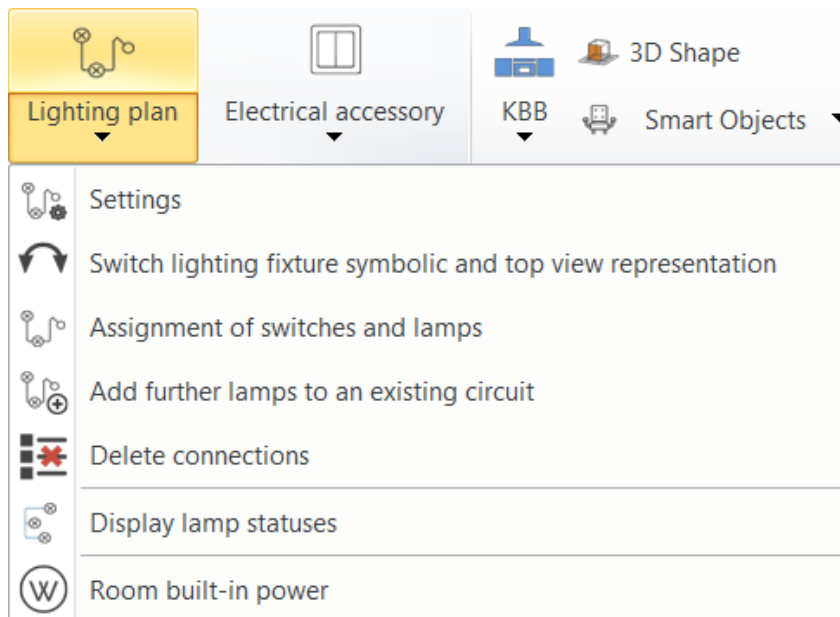

5.1.1. Lighting fixtures

To create a lighting plan, we recommend assigning the lighting fixture type to the lamps on the floor plan. By turning on the symbolic mode, we can create a consistent floor plan in accordance with the lighting fixtures types.

There are five types of lighting fixtures such as ceiling, wall, table, standing, spot. We have to assign these to the lamp to create an accurate lighting plan.

The assignment can be executed using the local menu of the lamp, or in Properties dialogue under Lamp settings; or using the Lighting fixture tool under Ribbon menu / Interior / Lighting group.

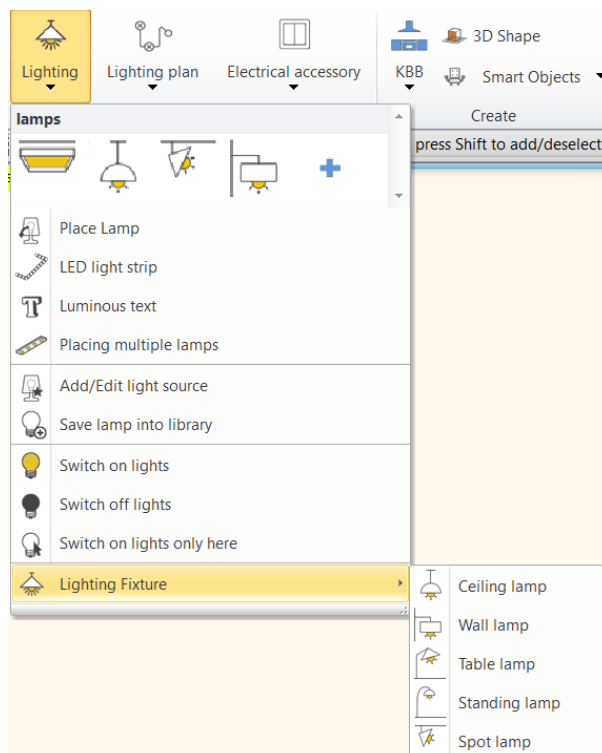

5.1.2. Settings

The Settings dialogue can be opened from the Interior / Lighting plan tool group. Here you can replace the lamps representation on the floor plan with a symbols. For replacement, it is essential to define the types of lighting fixture such as ceiling, wall, table, standing, spot lamp: we have to assign these types to the lamps.

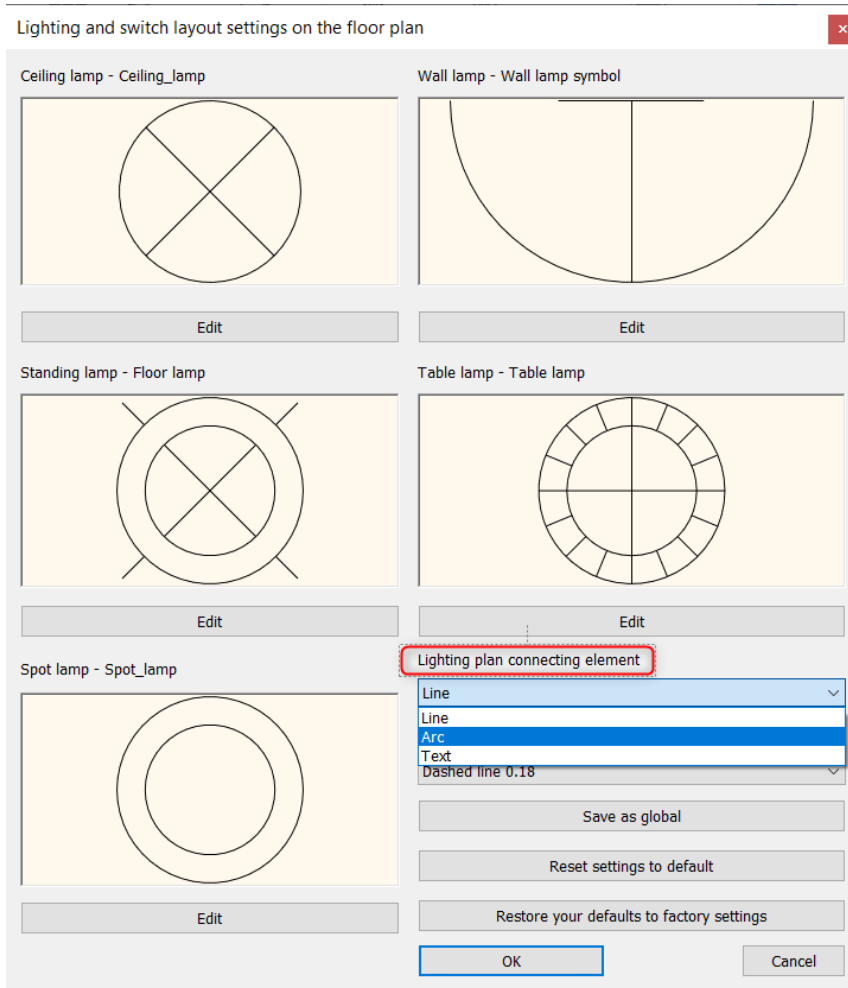

Lighting plan connecting element

We can choose from line, arc and text.

Here you can also set the style of the connecting element. We can create new styles for representation in the Line, Arc, Text properties dialogue window.

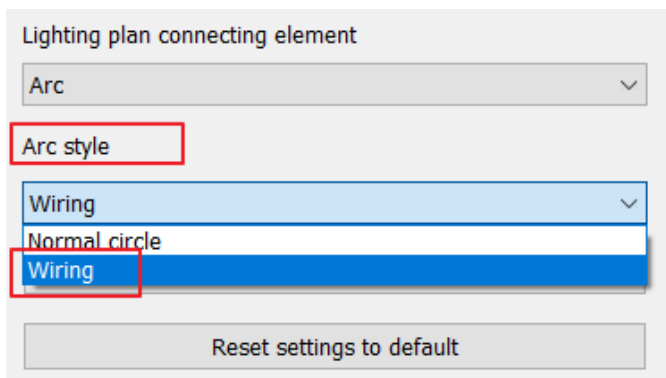

Examples:

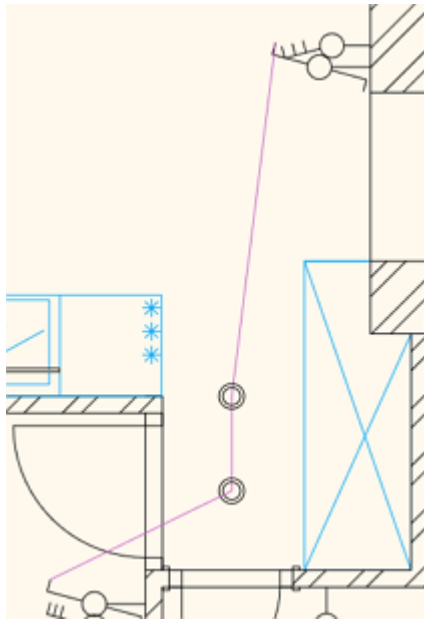
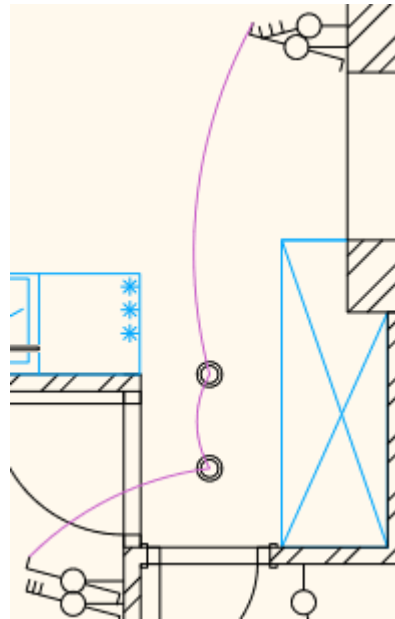
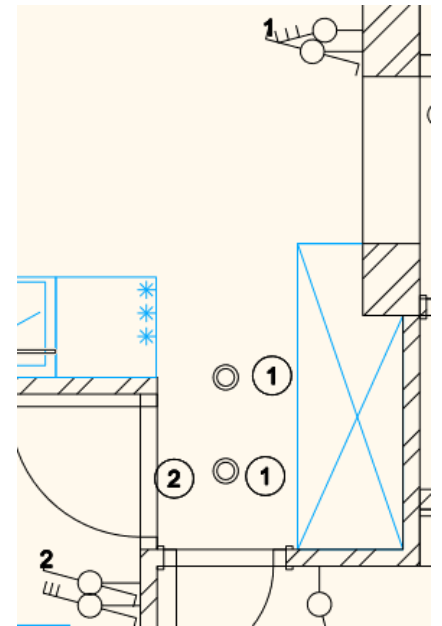
Line**Arc****Text**

5.1.3. Switching between lighting fixtures symbolic and top view representation

This command switches between the symbolic representation and the top view representation.

5.1.4. Multi-pole switches

In case of multi-pole switches, we can designate the number of the ways in Properties dialogue. This way we know the number of the closed path for electrical circuits.

All floors	Edit
Position	
Absolute elevation	1.2 m
Description	* VARIES *
Electrical Accessory	
Use Plate + Gang unit(s)	<input checked="" type="checkbox"/>
1-5 Gang solutions	1
Number of ways	3
Direction of inclination	0°
Angle of inclination	0°
Gang unit(s)	
Material	Corpus_white
Thickness	0.005 m
Border Gap	0.002 m

5.1.5. Assignment of switches and lamps

The lighting plan represents the connection between the switches and lamps as a 2D element. The lighting plan is not displayed in 3D. In the example below, we chose the arc connection type, and we created an arc style with purple line colour. Assign switches to the lamps room by room.

You can reach the “Assignment of switches and lamps” command from Ribbon menu / Interior / Lighting plan or by clicking on the free pole of switch the command automatically comes up.

- Select the switch, then the lamp.
- Connect them by using the arc starting from the lamp’s midpoint to the switch.
- In case of more lamps, continue the selection.

The program automatically creates the connecting arcs.

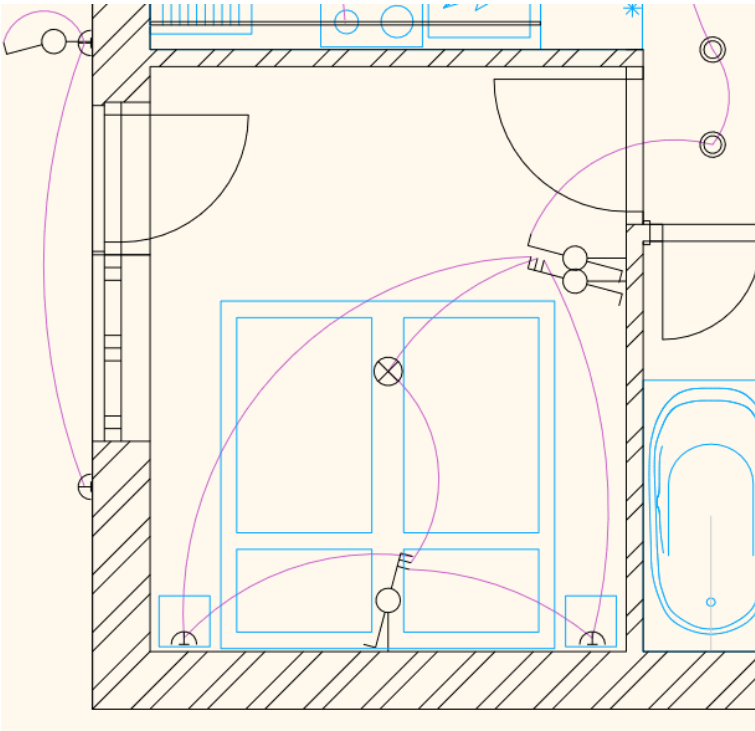

5.1.6. Lighting plan- delete connection

When selecting a switch, the connected poles are displayed in red.
The command depending on the selected item, disconnects the following assignments:

- ❖ Selecting a lamp: all connections of the selected lamp cease.
- ❖ Selecting a connection line: the link between lamps and connecting ways are deleted.
- ❖ Selecting a switch: all connections of the switch cease.

In the example below, we deleted the ceiling lamp connections.

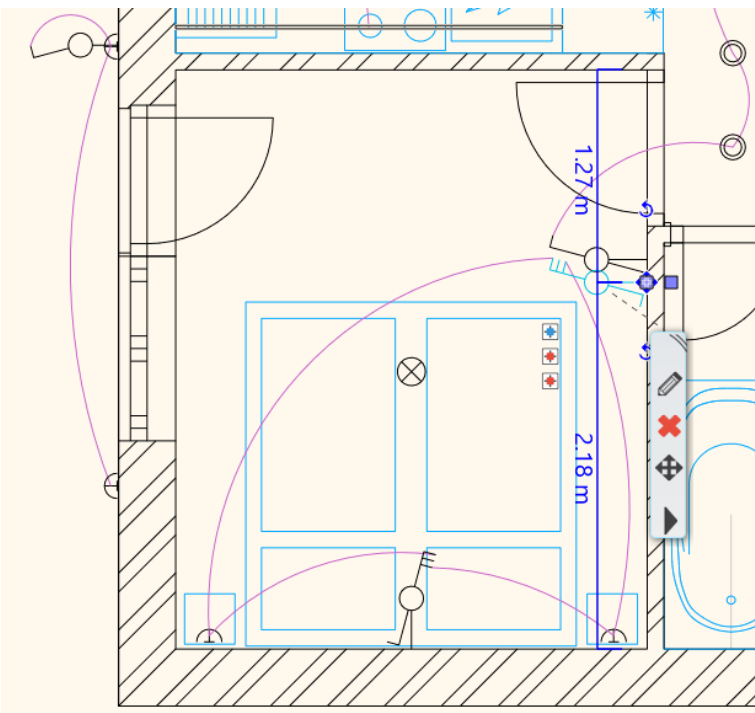

5.1.7. Lamps - Switches statuses

After the assignment of lamps and switches, we recommend checking the wiring status. This way we can get information about the connected or non-connected switches and lamps.

The command displays statuses in different colours:

- ❖ **Red:** connected switches and lamps
- ❖ **Blue:** lamps and switches with free poles
- ❖ **Green:** free lamps and switches

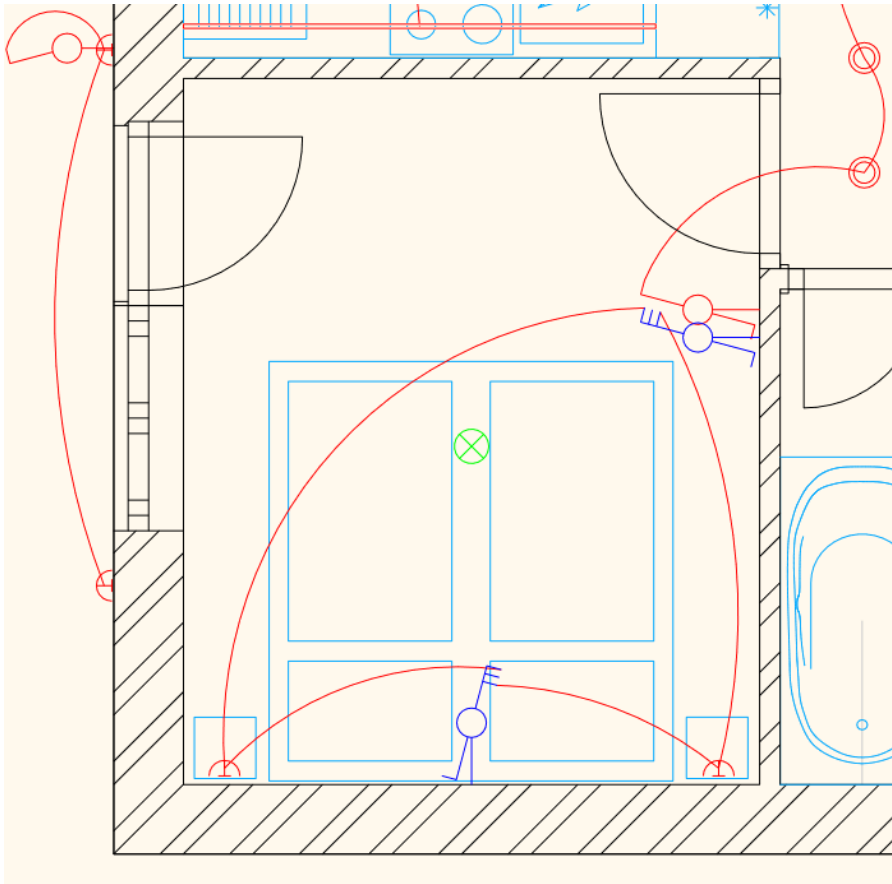

5.1.8. Add further lamps to an existing circuit

If we want to add more lamps to a current electrical path, we can do as follows:

- Select a non-connected lamp (1)
- Select a connected lamp on an electrical circuit to assign the non-connected item. (2)

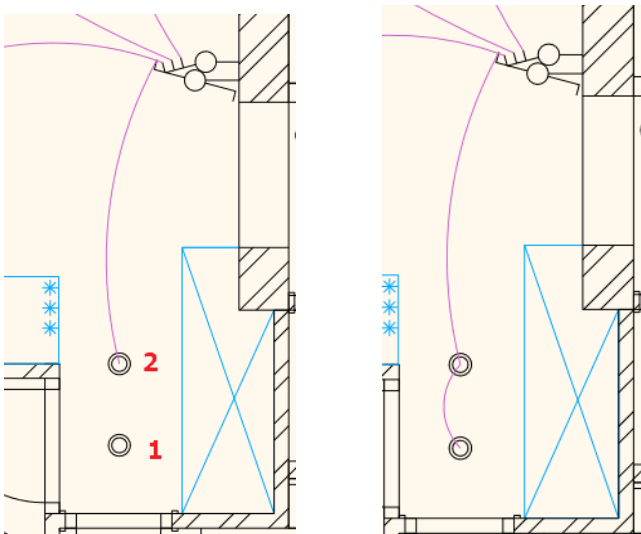

5.1.9. Room built-in power

This command helps to calculate the indicative value for the electric power consumption. For this we need the room plot stamp.

The basic data:

- ❖ Gross area,
- ❖ Lighting efficiency,
- ❖ Illumination (lx),
- ❖ Average luminous efficiency index of the light source (lm/W).

The built-in power (W) is an indicative value for providing the planned luminous flux (lumen) in the room.

- Click on the plot stamp.
- Set the parameters.
- Place the built-in power.

Determine the lighting needs in a room ✕

Gross area	27.93 m ²
Environmental factor	1.25 - Clean interior space ▼
Illumination (100 lx < E < 500 lx)	300 - Community spaces ▼
Lighting Efficiency (Direct - Indirect)	0.5 - Direct lighting ▼
Luminous flux to be integrated [lm]	20948.91 lm
Average luminous efficiency index of light sources	LED light source 90 lm/W ▼
P - Built-in power [W]	232.77 W

i Source: experience based data.
Software vendor is not responsible for the data, it's accuracy and correctness.

* PRODUCER SHALL NOT BE LIABLE IN ANY MANNER WHATSOEVER FOR THE RESULTS OBTAINED THROUGH THE USE OF ANY PROGRAM OUTPUT

OK
Cancel

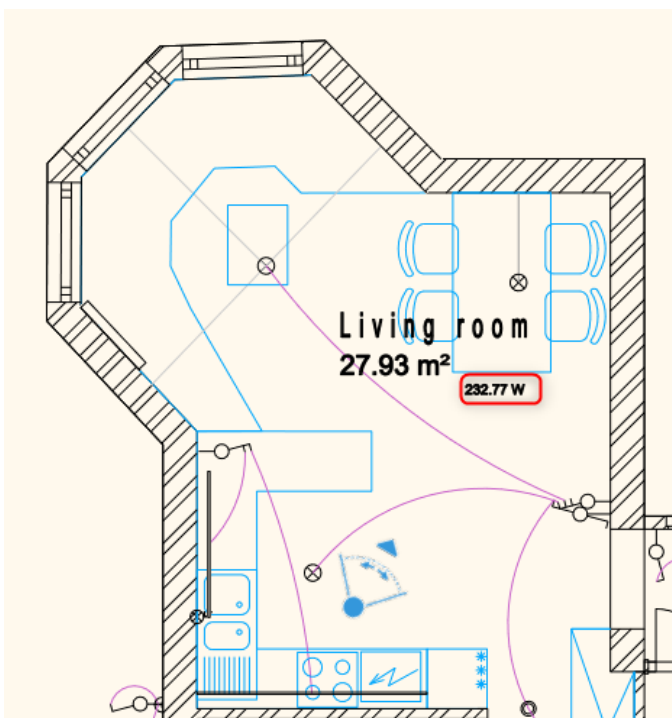

5.2. Socket layout

The task is to measure the distance and mounting height of the sockets.

- In the project, select “Socket layout” layer variation. We start from this position.

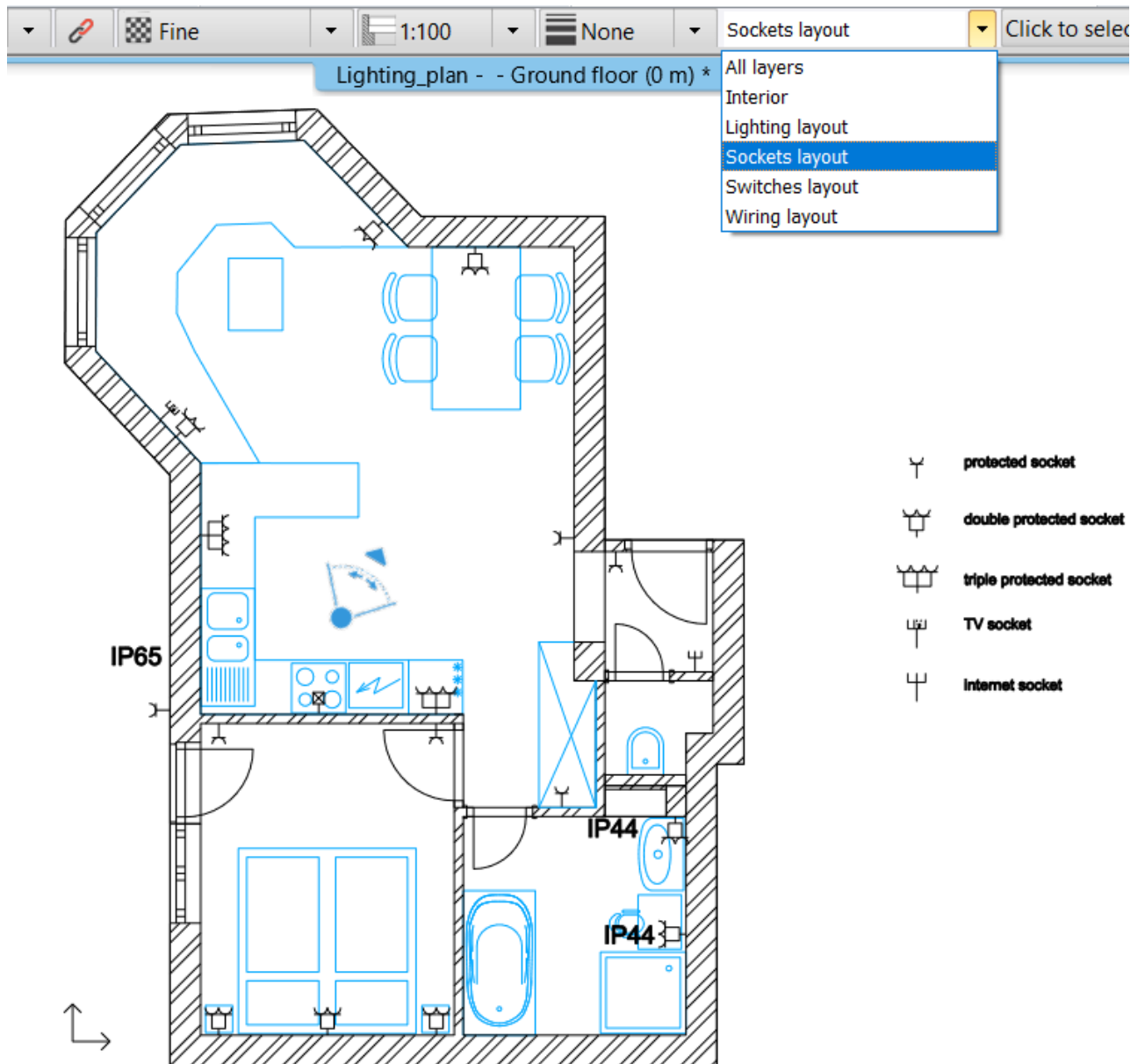

- Under the Ribbon menu / Dimension / Switches/Socket command group, select commands to get the dimensions relative to walls and openings; and show the relative height on the floor plan.

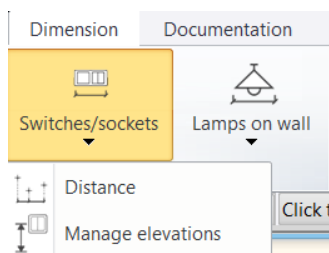

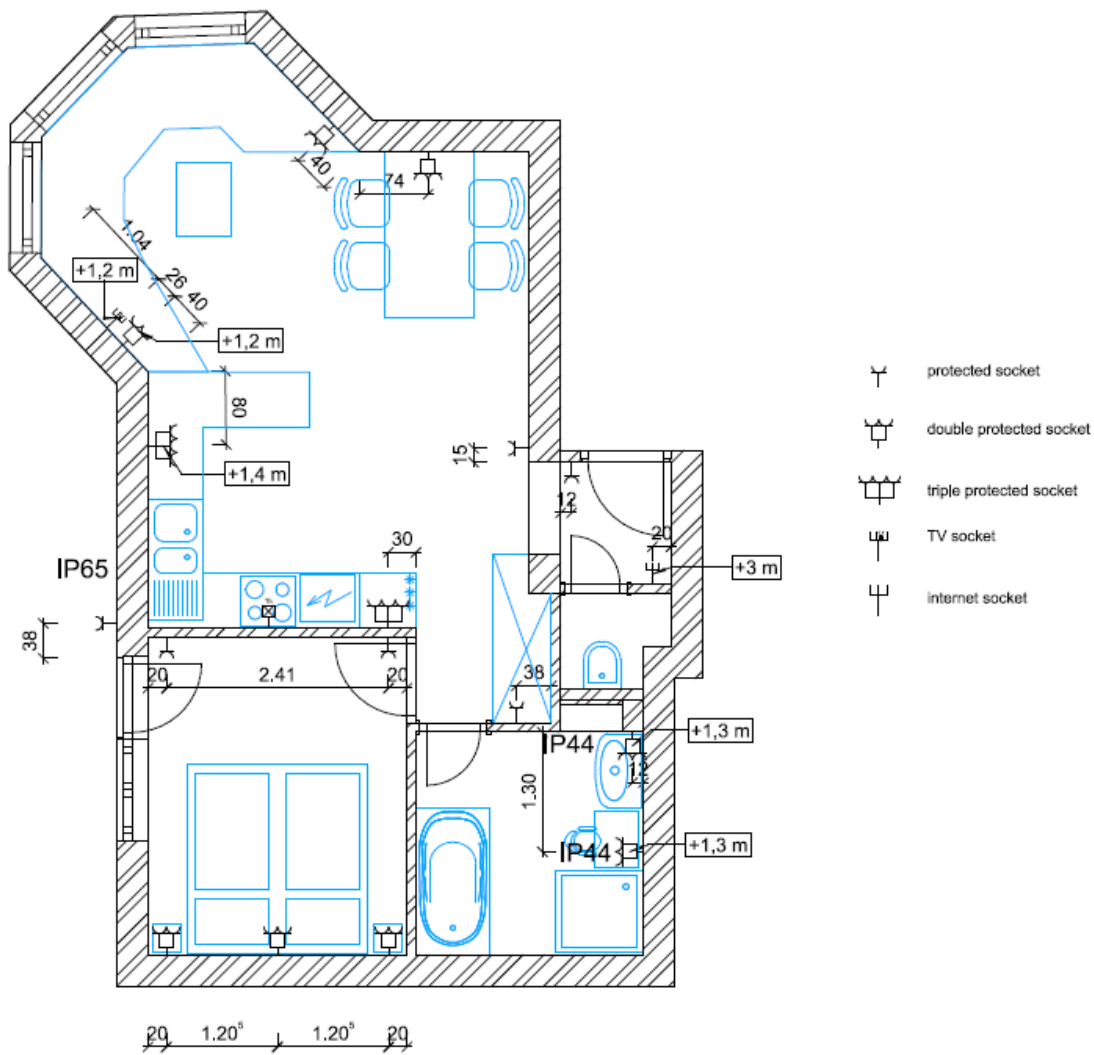

5.3. Switch layout

The task is to measure the distance and mounting height of the switches.

- In the project, select “**Switch layout**” layer variation. We start from this position.

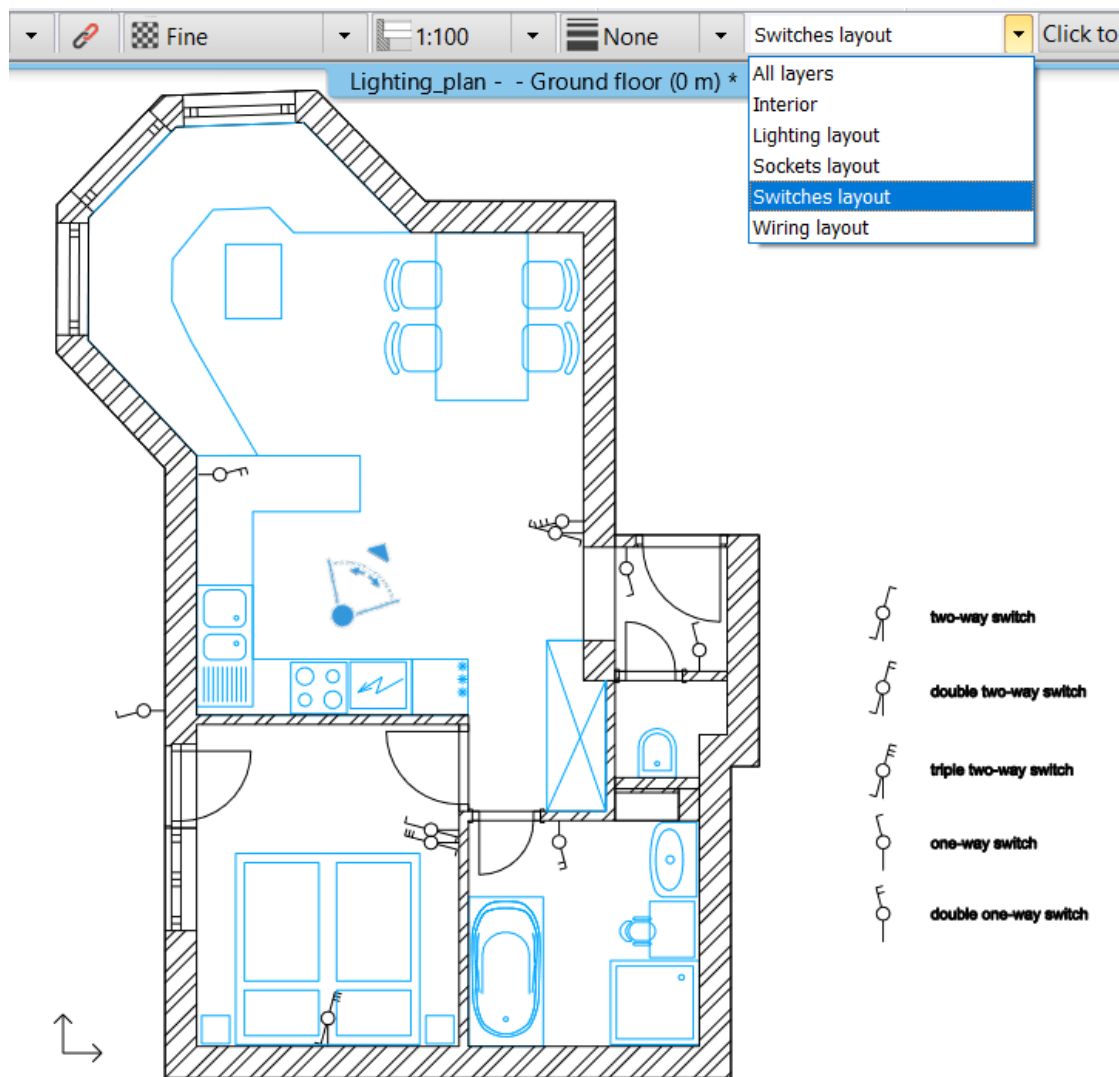

- Under the Ribbon menu / Dimension / Switches/Sockets command group, select commands to get the dimensions relative to walls and openings; and show the relative height on the floor plan.

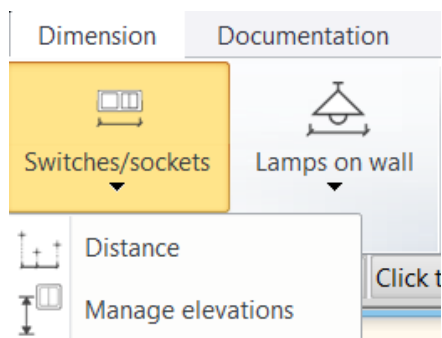

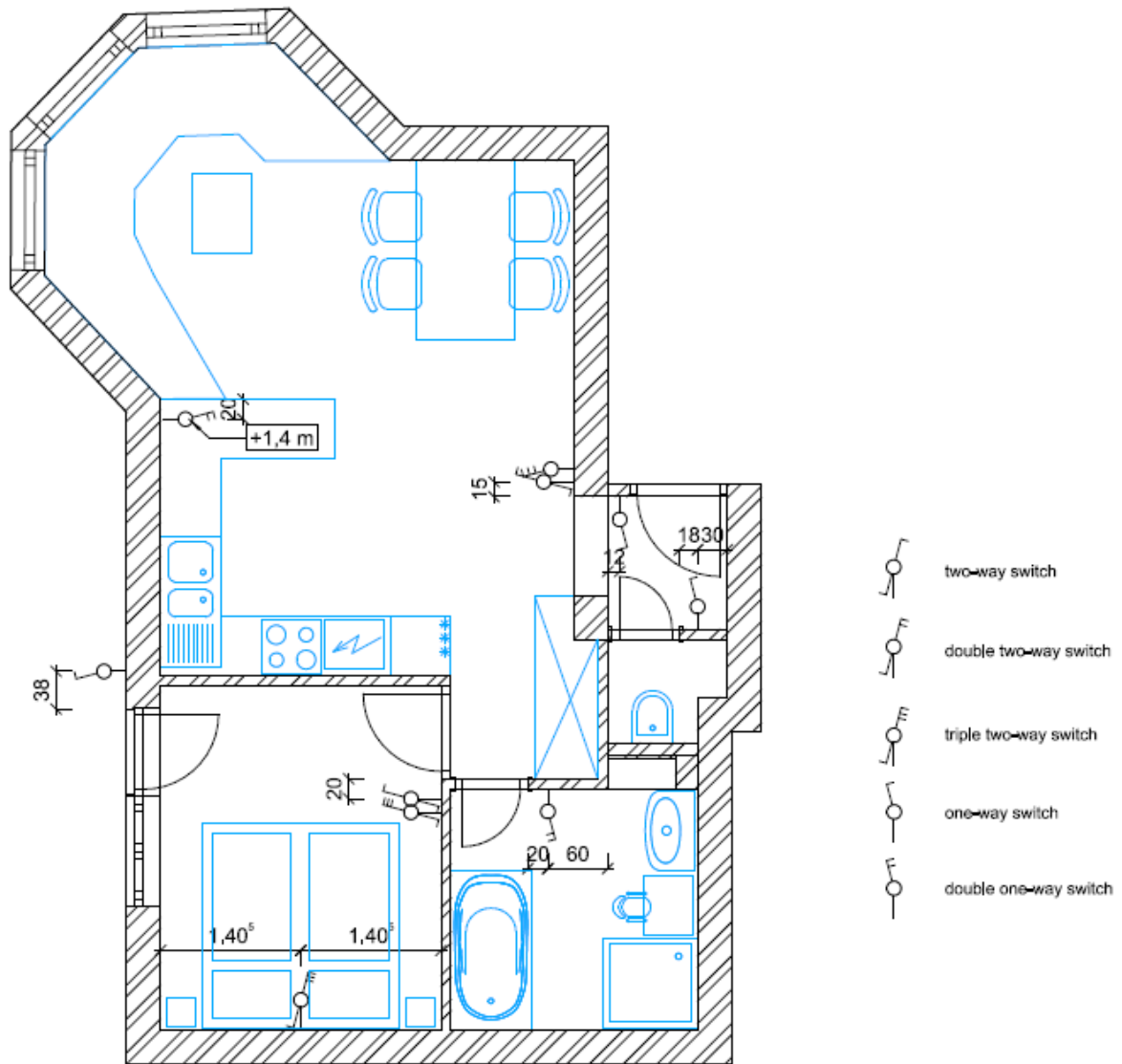

5.4. Lighting layout

The task is to measure the distance and mounting height of the lamps.

- In the project, select “**Lighting layout**” layer variation. We start from this position.

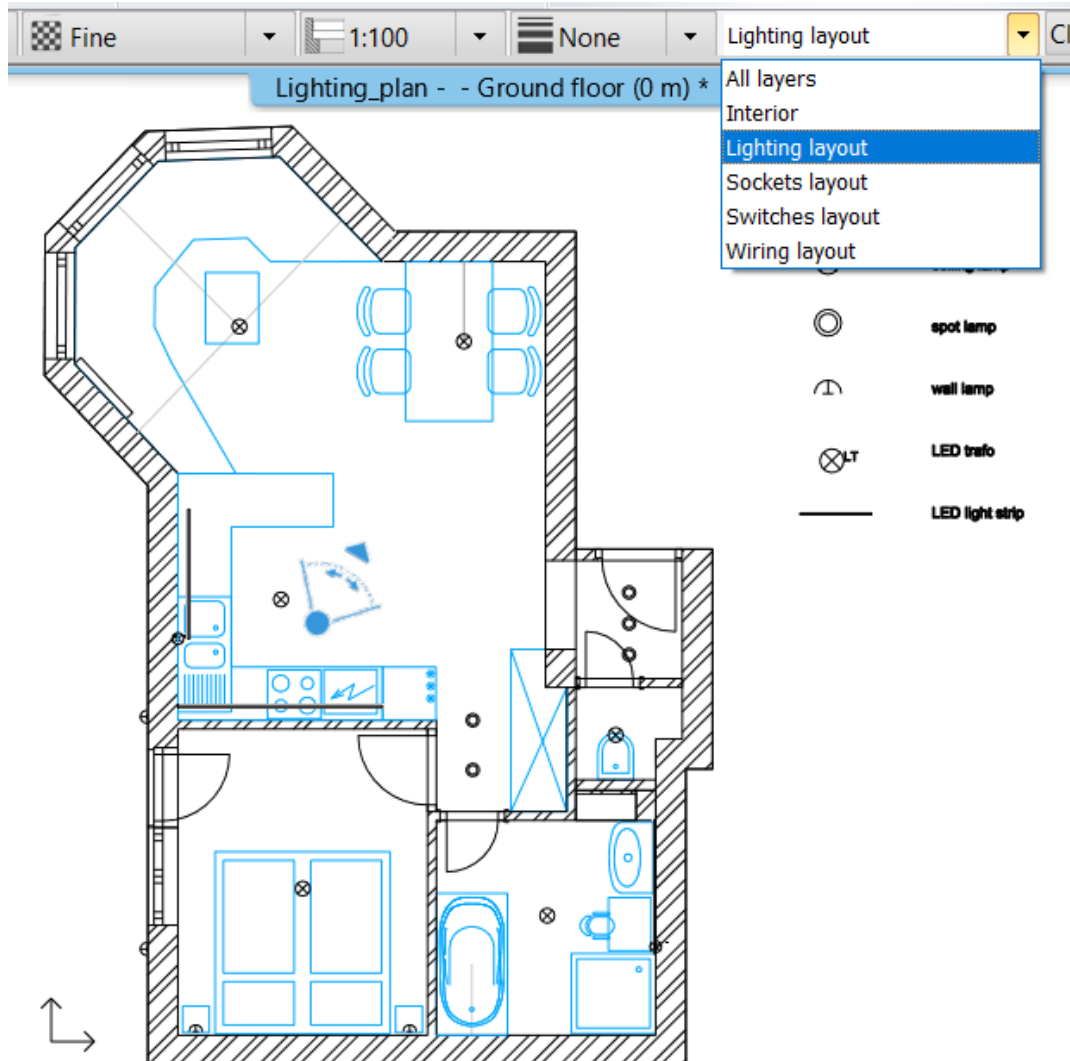

- Under the Ribbon menu / Dimension / Lamps on wall command group, select commands to get the dimensions relative to walls and openings; and show the relative height on the floor plan. This command is only for wall lamps. To dimension ceiling lamps use Length dimension command.

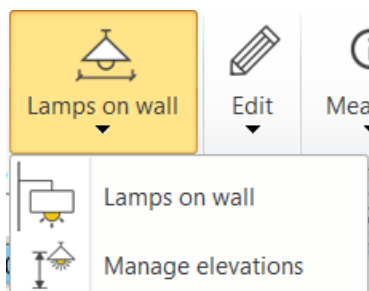

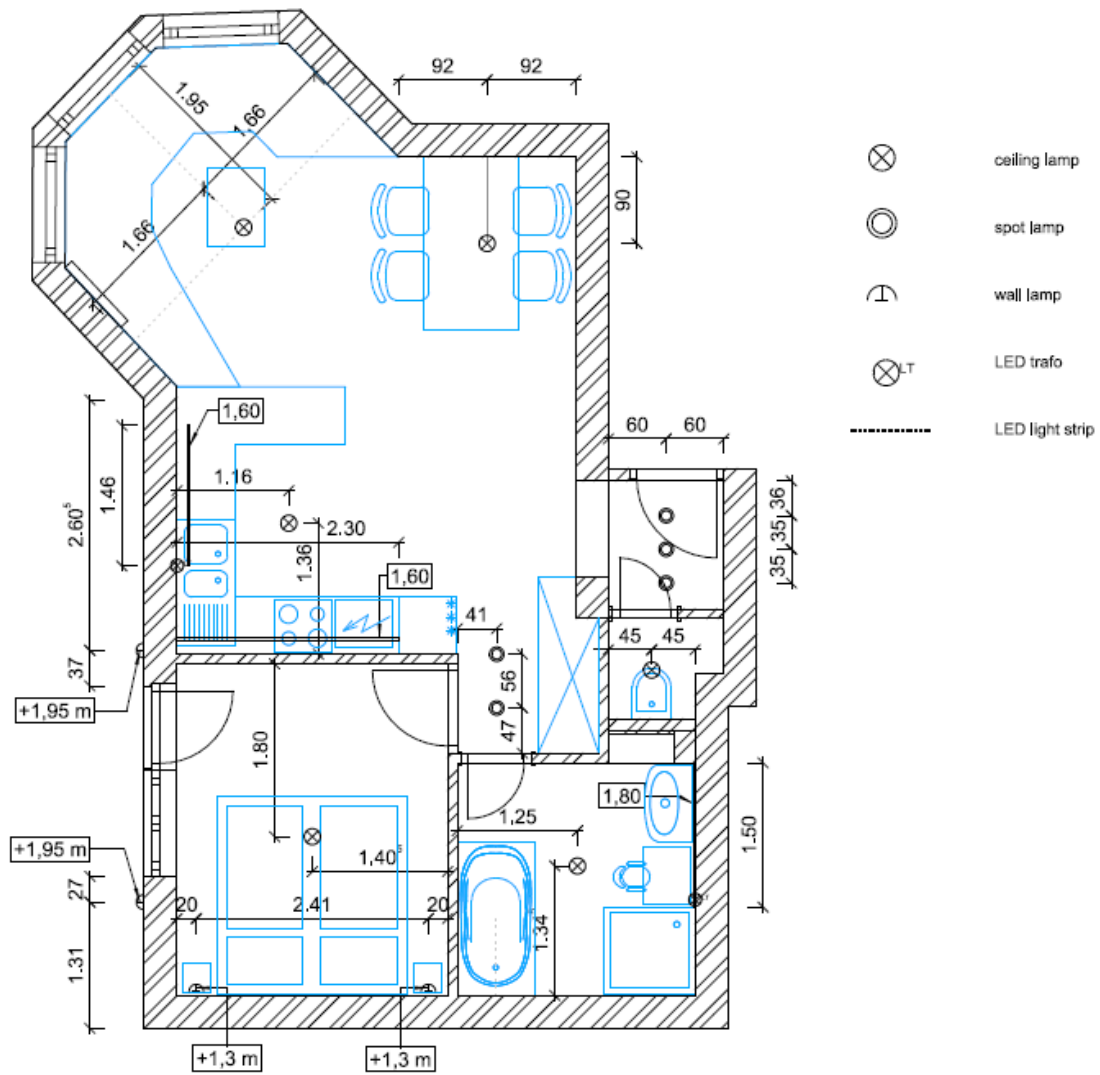

6. Workshop: Suspended ceilings

6. Workshop: Suspended ceilings

Designers mostly create a suspended ceiling as a decorative element, but it is also useful in terms of insulation and acoustics. In ARCHLine.XP we can create a suspended ceiling such as:

1. **Grid ceilings (such as a suspended grid system)**
2. **Plain ceilings (such as plasterboard)**

These types of suspended ceilings differ from each other in structure and appearance. Through the following project, we will explain these differences.

- Open ...\Documents\ARCHlineXP Draw\2020\Interior_Advanced_Course\6_Suspended_ceiling\01_Office_suspended_ceiling_plan_START.pro file. Save the project under a new name.

6.1. Grid ceiling

The components of the grid ceiling are the main and cross runners; and panels. Ceiling is a host element. It means the ceiling can host components into its structure. It can include light fittings, ceiling fans, CCTV cameras, etc.

6.1.1. Creating grid ceilings

The grid ceiling has a specific pattern, in which the elements are interchangeable, geometric shapes are forming the ceiling (typically square or rectangular shaped ones).

- ❖ **Grid Auto Ceiling:** the program automatically recognises the closed boundary of the room inside the building, clicking inside the room the program automatically creates the grid ceiling.
 - ❖ **Grid Ceiling by polygon:** by drawing a closed polygon, the program creates the grid ceiling in the defined shape.
 - ❖ **Grid Auto ceiling in all rooms:** the program automatically recognises the closed boundary of each room inside the building, and the program automatically generates the grid ceiling throughout the building.
- Place grid ceilings by using the **Ribbon menu / Building / Ceiling / Grid Auto Ceiling** command and remove the unnecessary one keeping only those that are in the rooms marked with green squares.



6.1.2. Grid Ceiling Properties

By opening the Grid Ceiling properties window, we can specify its parameters to the most optimal arrangement.

6. Workshop: Suspended ceilings

- Select those grid ceilings, where the light arrangement differs from the green square. Modify the grid ceiling properties the way that the lamps lie over the green squares on the floor plan.
- Basic modification can be arranged by right-clicking on grid ceiling; this way, you can define the reference point and direction of the rotation on the floor plan in the given room.
- You can change the lamp distribution and other items settings on the corresponding tab in the Grid ceiling properties window.

Type and distribution

The basic structure can be set here: by choosing the strip structure, the grid ceiling is created by rectangular elements all along the entire width of the room, while the suspended grid ceiling consists of units with a given width and height. On this tab, we can define the size of the units, the offset, the direction of the rotation relative to North and the reference point.

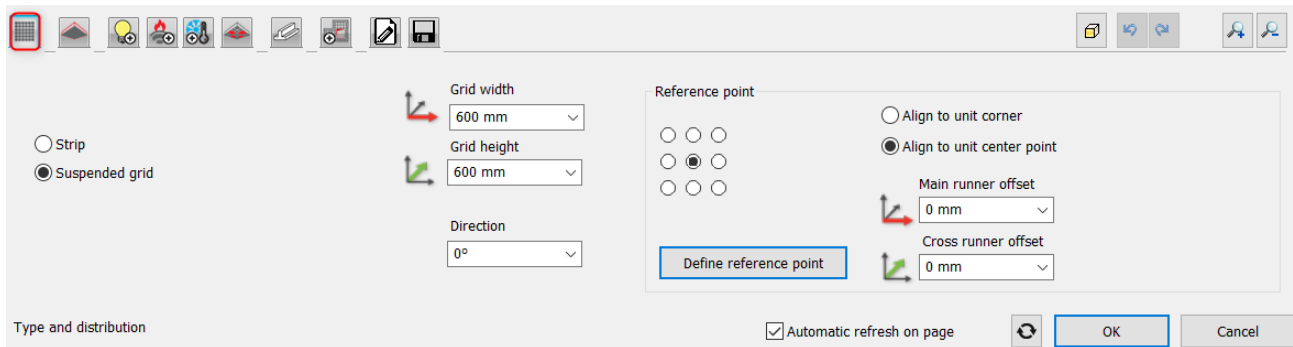

Default units

On this tab, you can customise the default units, for each component that will be applied on the entire ceiling. Here you can select the unit types, lamp units, fire protection units, air distribution units as well.

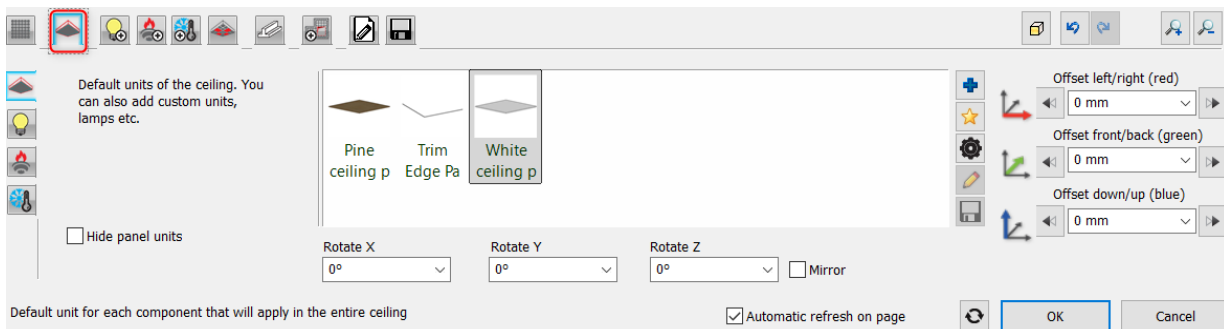

Lamp, Fire Protection, Air Distribution and Other Units

Under these tabs, you can define the lamp unit, fire protection unit, air distribution unit, and other units to be built-in. Also, you can set the type of the predefined placement on the ceiling, furthermore here you can change the unit type individually in case that is not the same as the default unit setting.

When selecting different units the size is an essential factor, except the fire protection unit, all others should fit in the grids.



Grid ceiling – grid system

The grid system is based on default profiles in case of the grid ceiling. Also, you can create a customised profile by drawing a cross-section profile. You can set different profiles for the Main runner, the Cross runner and the Perimeter Wall Angle.

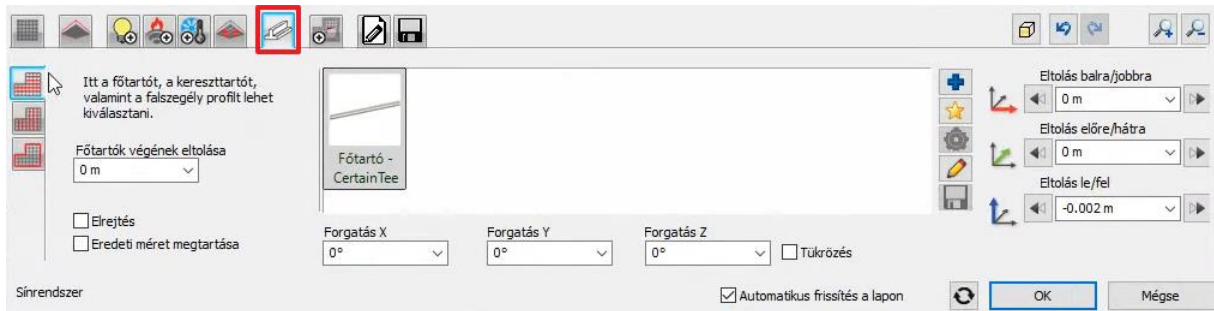

Holes and insets

An area can be created in the suspended ceiling with a different shape, where a suspended ceiling can be placed with customized settings.

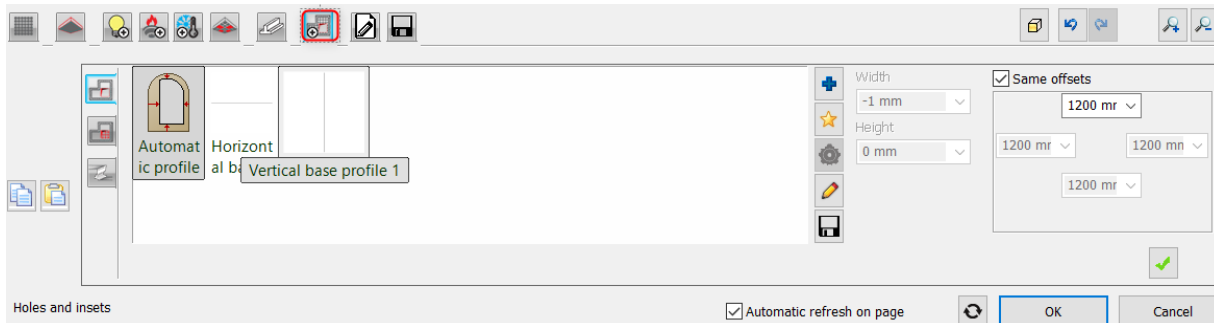

General settings

Here you can set the presentation of the grid ceiling on the floor plan.

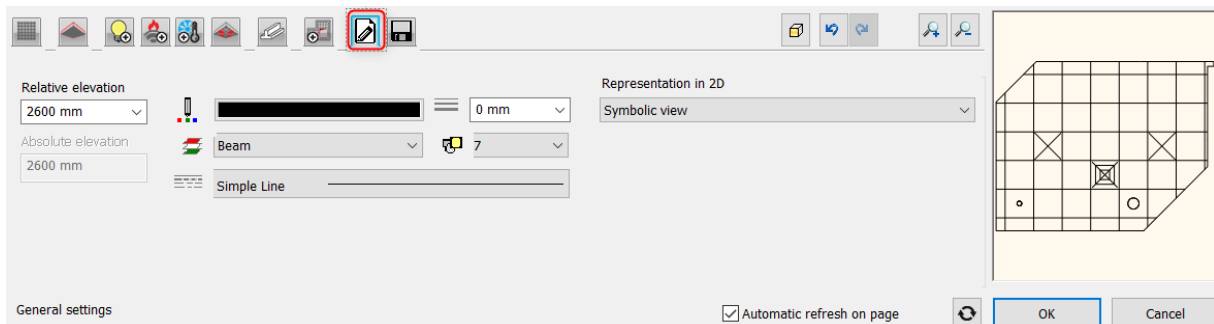

Save

You can save the newly created or modified ceiling into the Design Centre by using the *Save* or the *Save as* option. You can use the saved assets any time later on.

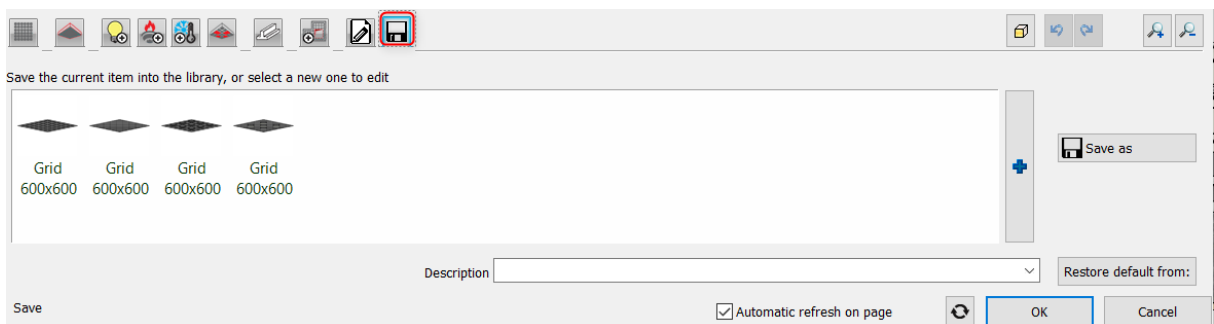

6.1.3. Rotate the grid layout on the floor plan

If it is necessary, you can rotate the grid layout directly on the floor plan by using the “Define reference point and direction” commands from the local menu of the grid ceiling.

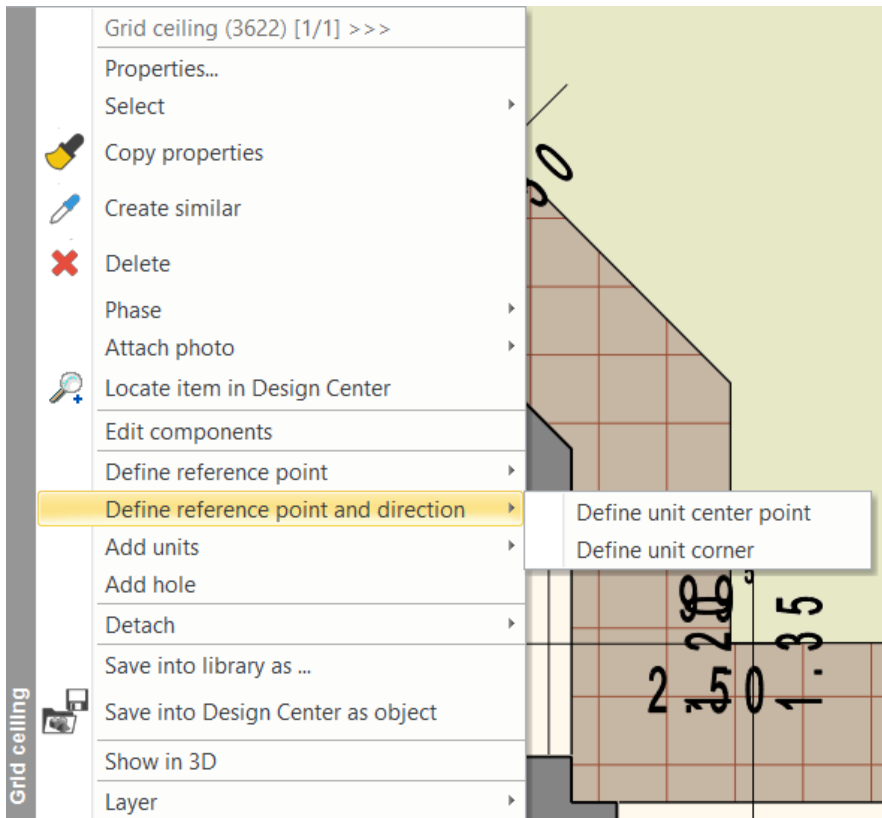

6.1.4. Modifying units on the floor plan

On the selected grid ceiling, the different units appear with different markers. Using these markers, you can copy, move and delete individual units.

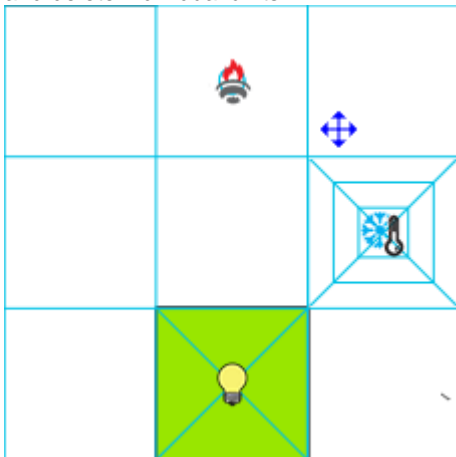

6.1.5. Add units on the floor plan

Right-click on the 2D symbol of the grid ceiling on the floor plan, and from the local menu choose “Add units” tool. Select the unit type and place the desired item on any empty grid points.

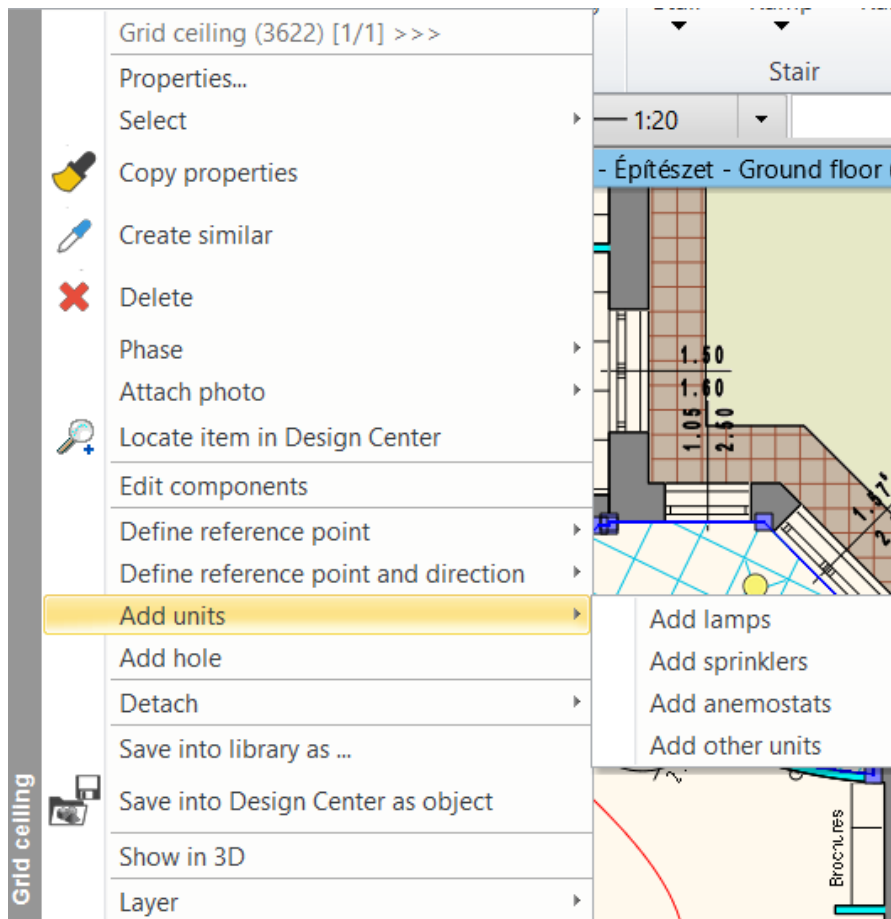

After placing grid ceilings, the floor plan should look as below:

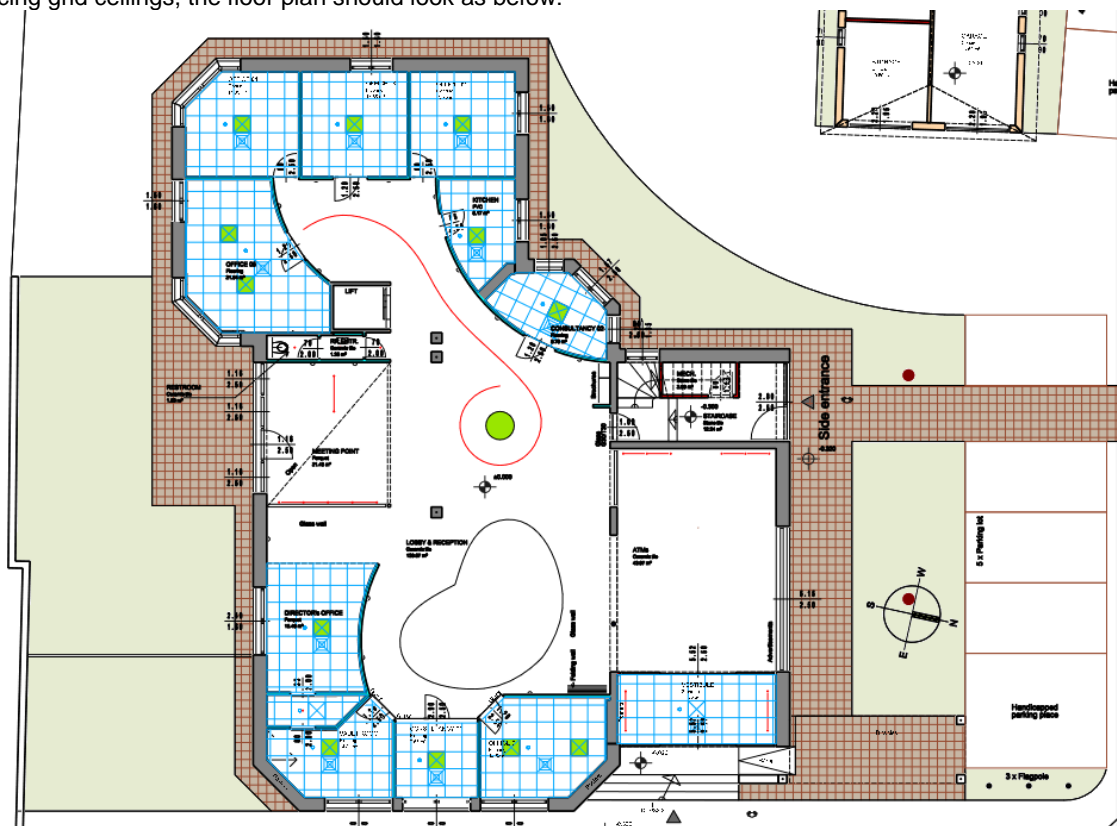

6.2. Plain ceiling

The plain ceiling aims to create a suspended ceiling which has a smooth, even surface, and its shape can be fully customised.

6.2.1. Creating plain ceilings

You can create plain ceilings automatically or manually by drawing the contour of the ceiling.

- ❖ **Plain Auto ceiling:** the program automatically recognises the closed boundary of the room inside the building, clicking inside the room the program automatically creates the plain ceiling.
- ❖ **Plain Ceiling by polygon:** by drawing a closed polygon, the program creates the plain ceiling inside the defined shape.
- ❖ **Plain Auto Ceiling in all rooms:** the program automatically recognises the closed boundary of each room inside the building and automatically generates the plain ceilings throughout the building.

- We place plain ceilings in the remaining rooms on the floor plan by using the **Plain Auto Ceiling** command.
- In the stairway, use the **Plain Ceiling by polygon** command, and draw the contour of the entire area. Right-click on the stair and from the appearing menu select the **"Cut slabs above the stair"** command.

After placing plain ceilings, the floor plan should look as below:



6.2.2. Plain Ceiling Properties

Within the plain ceiling properties, there are the same options as we described in case of the grid ceiling apart from the grid structure settings.

- In the ATMs room set the following plain ceiling properties:
- On the Lighting tab, select Automatic profile and set the distance to 300 mm from the edge of the plain ceiling.

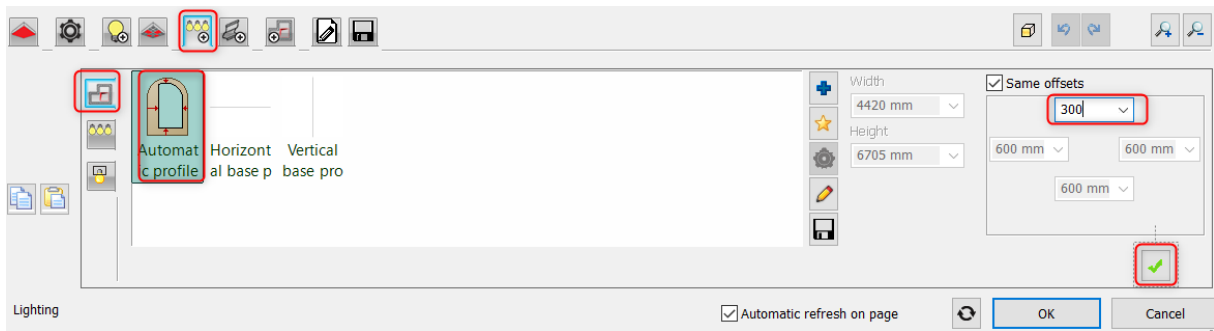

- Move lamps 50 mm higher to place them on the ceiling plane, then cut the ceiling for the lamps.

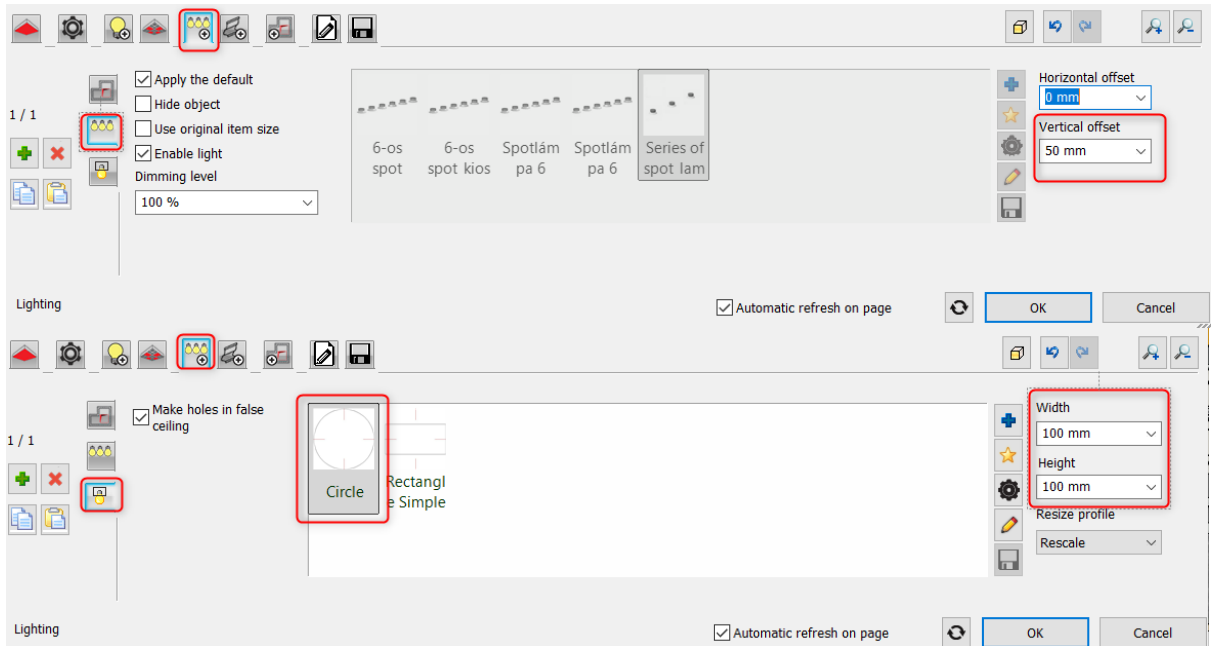

- Create a hole 600 mm from the edge of the plain ceiling, then move it 100 mm higher.

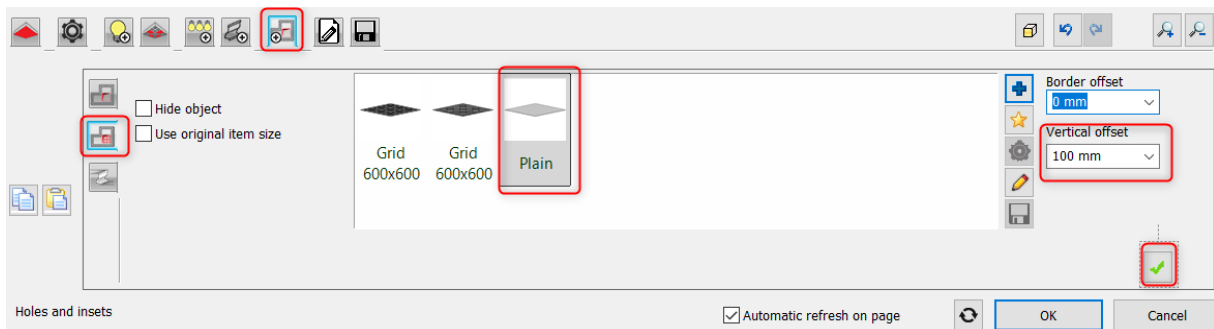

- Fill the gap between the plain ceilings with a Simple border.

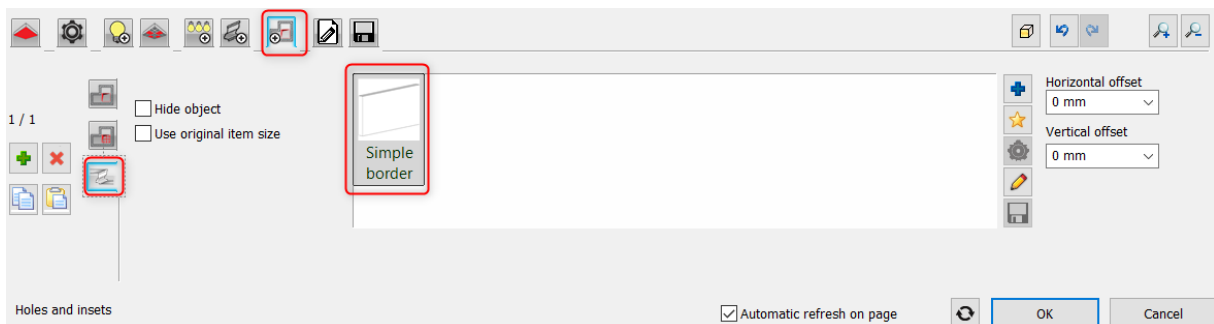

6. Workshop: Suspended ceilings

The picture below shows the result on the floor plan:

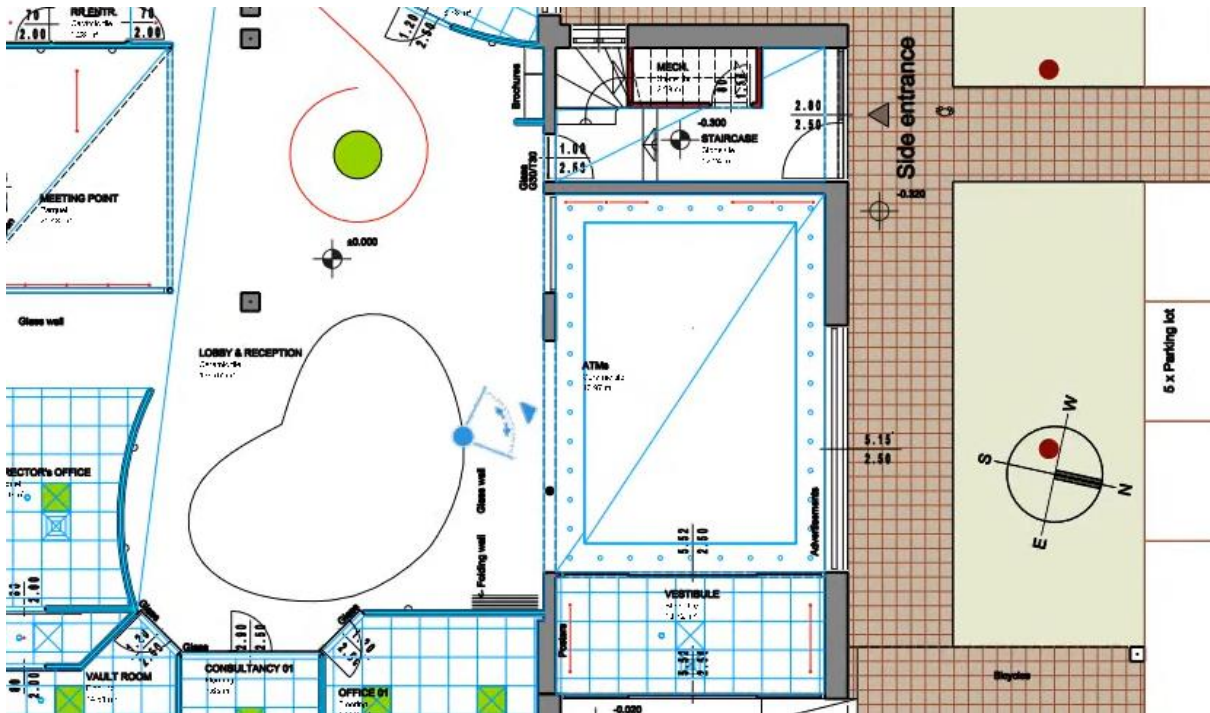

The lamp distribution can be fully customised in the Plain ceiling properties dialogue window, under the Lamp units tab in the appearing "Distribution mode" window.

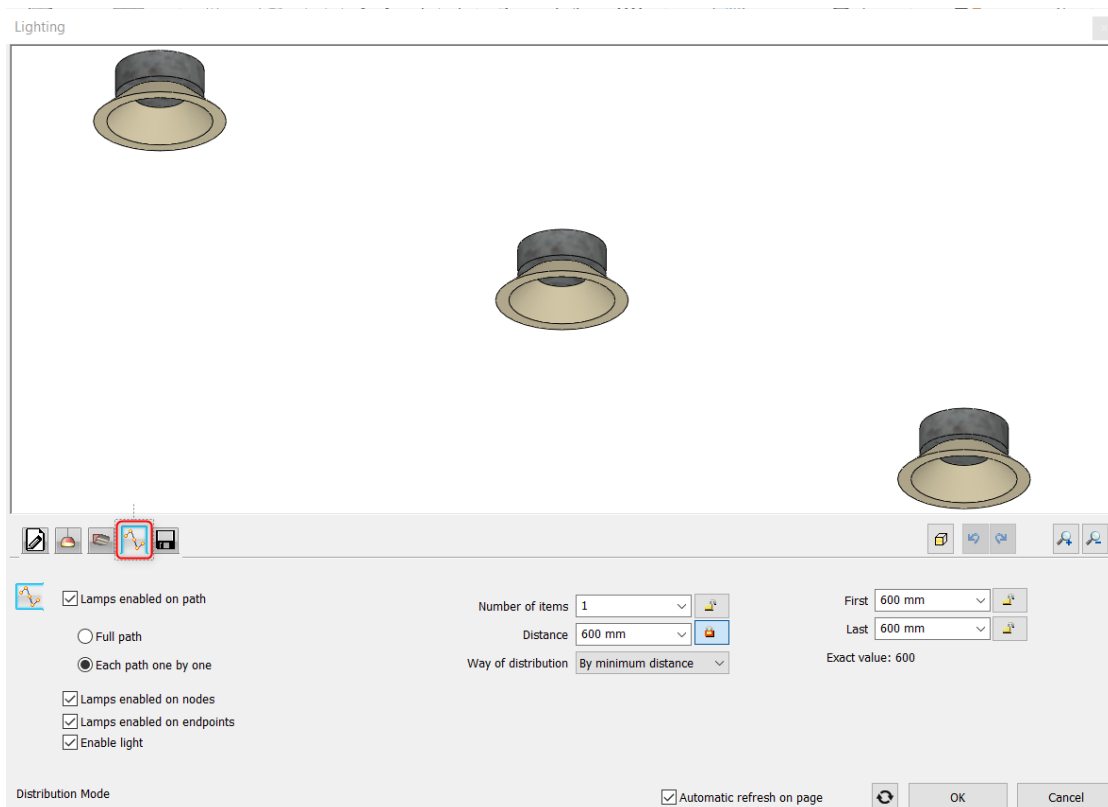

On the floor plan, you can see that in the Lobby & Reception area, there are irregular shapes. You can create a new profile for the plain ceiling by picking the shape on the floor plan. Set the properties and place it 100 mm below the ceiling.

It is good to know that you can create a custom shape as it is shown on the floor plan when you choose the Holes and Inset and click on the Define profile button. Use the Closed loop command of the ribbon bar and click inside the shape.

The end result should look like this:

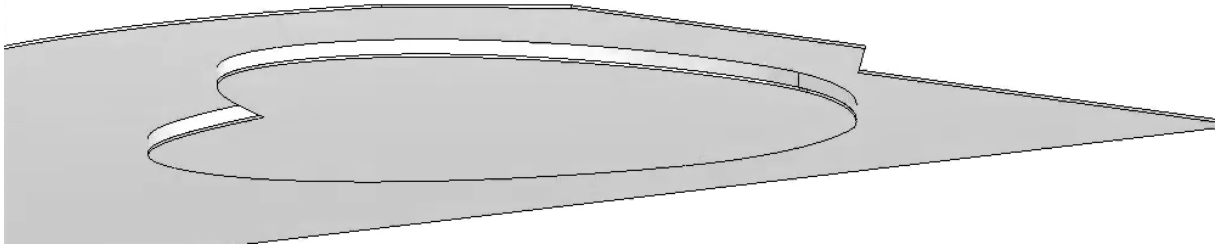

On the floor plan, the spline represents a lamp distribution path.

In the Plain ceiling dialogue window, select the **Lighting** tab, choose the **Define profile** command and select the path where to place lamps. The path is a spline so now use the "Select an item" tool from the Profile editor mode ribbon bar. Just click on anywhere on the spline and the program automatically creates the path for the spotlights. Now you have to set the spotlights' properties.

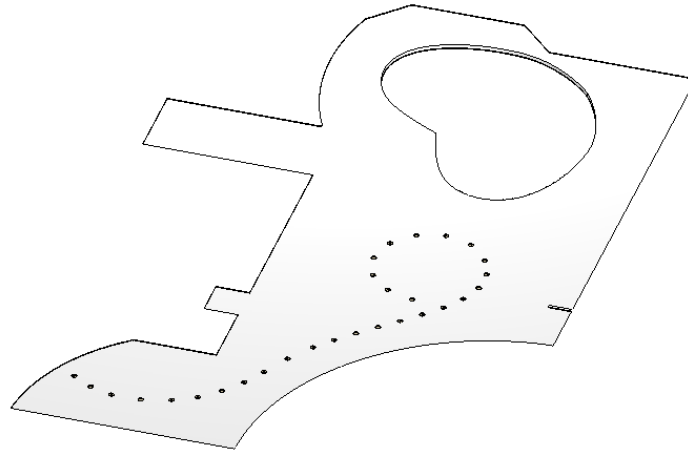

When we finish with the entire project, it should look similar to the image below:

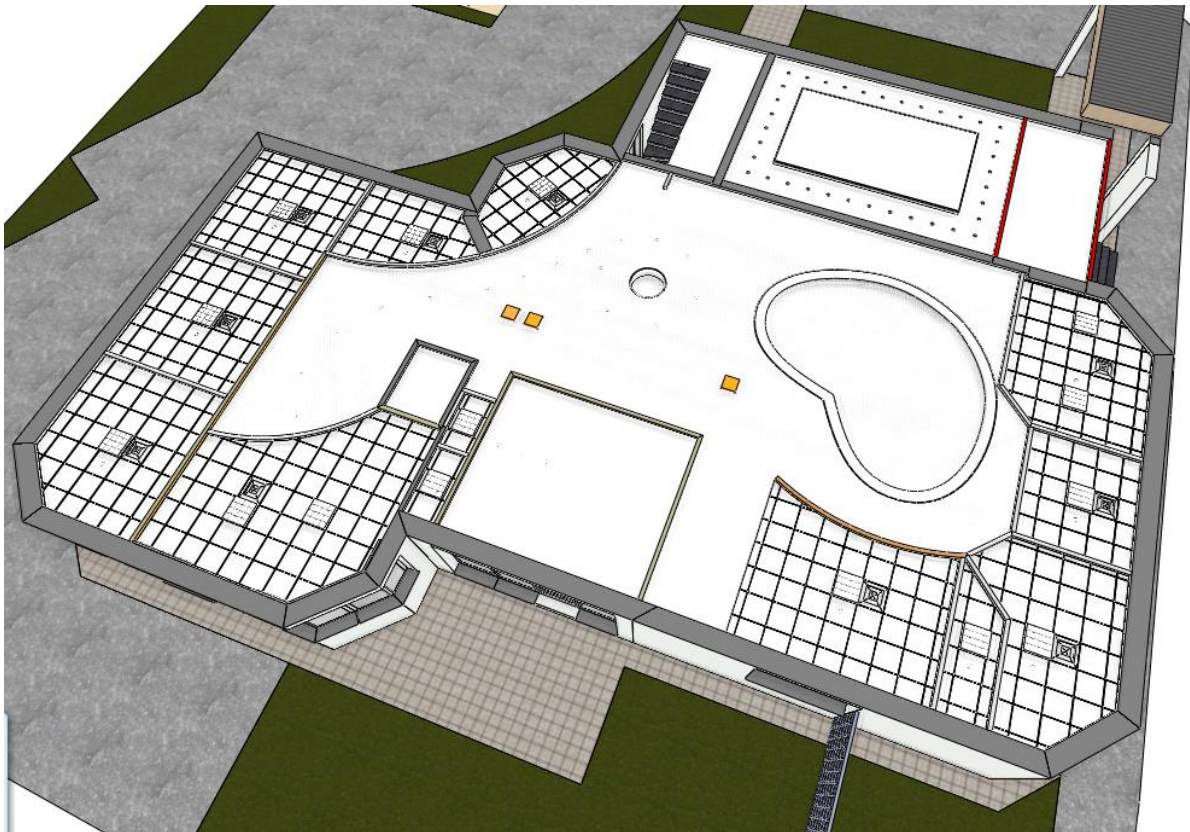

7. Workshop: Curtain walls

7. Workshop: Curtain walls

We frequently use curtain walls as room divider or as a building's exterior such as a shop front. Because they can be installed in any size and design, you can create unique and visually stunning exteriors.

The curtain wall is a special wall and consists of the frame, panels and mullions. Doors and windows can be inserted in the curtain wall. Since the curtain wall is based on the wall tool, you can apply wall tools such as resizing, editing, joining. Curtain wall behaviour is the same as standard walls in connection to slabs, roofs and spaces.

We can solve many tasks with the curtain wall tool:

- ❖ create new curtain walls as room divider or shop front
- ❖ convert existing walls to curtain walls
- ❖ join more curtain walls
- ❖ create unique and customised glass insets in the wall

In the next example, we will alter an open-plan office in a way that we divide the space by functions, at the same time keeping the space open, airy and light.

- Open ...Documents\ARCHlineXP Draw\2020\Advanced_Course\7_Curtain_wall\Office_with_curtainwall_Start.pro file. Save it under a new name.

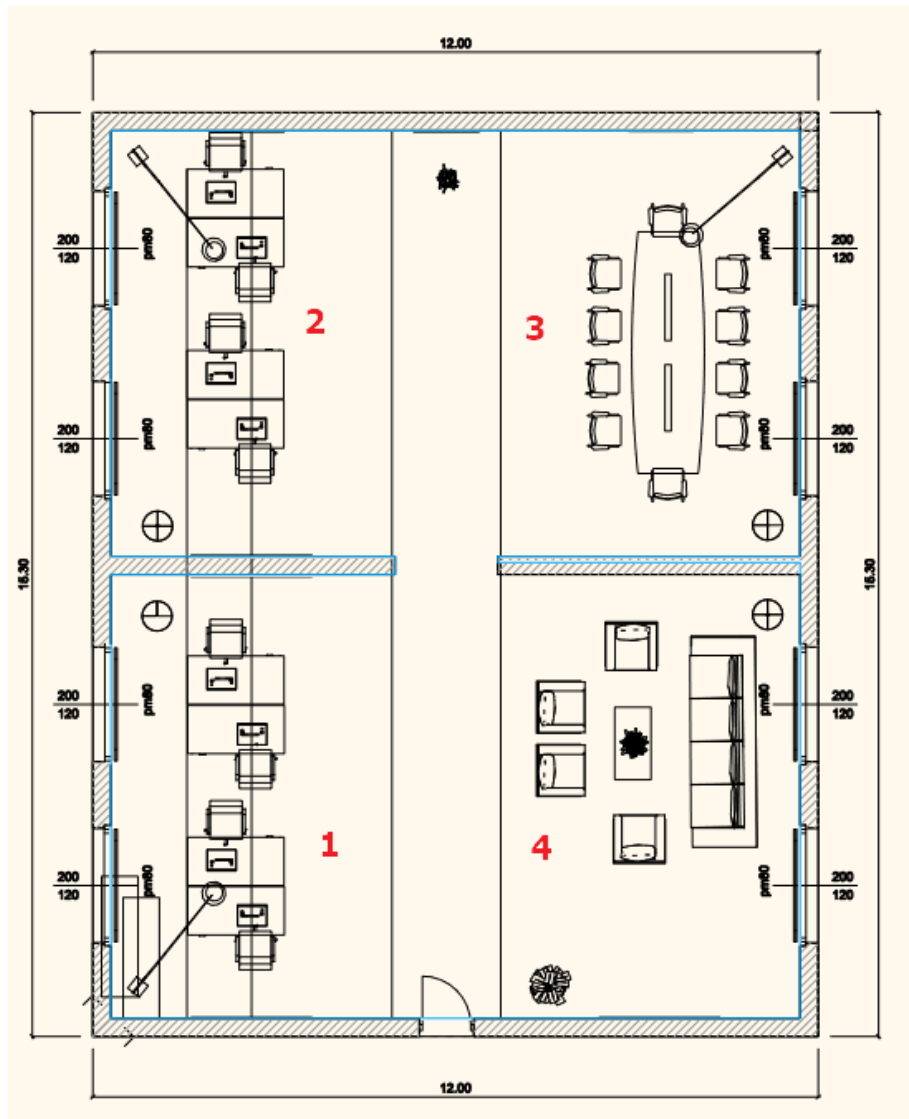

1. Office
2. Office
3. Meeting room
4. Lounge

7. Workshop: Curtain walls



7.1. Converting the 1st office to closed-space

Now we create a curtain wall to separate the first office space.

7.1.1. Set properties

First set the curtain wall's properties and save it under a new style.

- Use the following parameters as the diagram shows below:

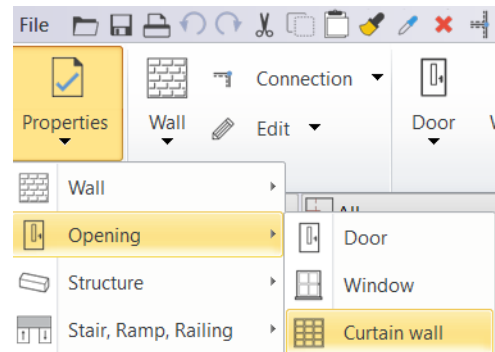

Main parameters

Curtain wall

Main parameters	Enclosing box width	7150 mm
Representation	Enclosing box height	2600 mm
Reveal, void, niche		
Basic geometry		
Outer handle		
Inner handle		
Accessories		
Interior and exterior sills		
Built-in details		

Hide opening and make a void	
Distance from frame	0 mm
General	
Layer	Wall - Partition wall
Colour	
Line type	Simple Line
Line weights	0.3 mm
Draw Order	8 - Bottom-most
Distance from wall corner	0 mm
Lining and architrave	
Dimension, consignment	
Thermal parameters	
Ratio (Illumination area)	100%
Ratio (Ventillation area)	100%
Wall properties	
Thickness	100 mm
Slant angle	90°

Basic geometry

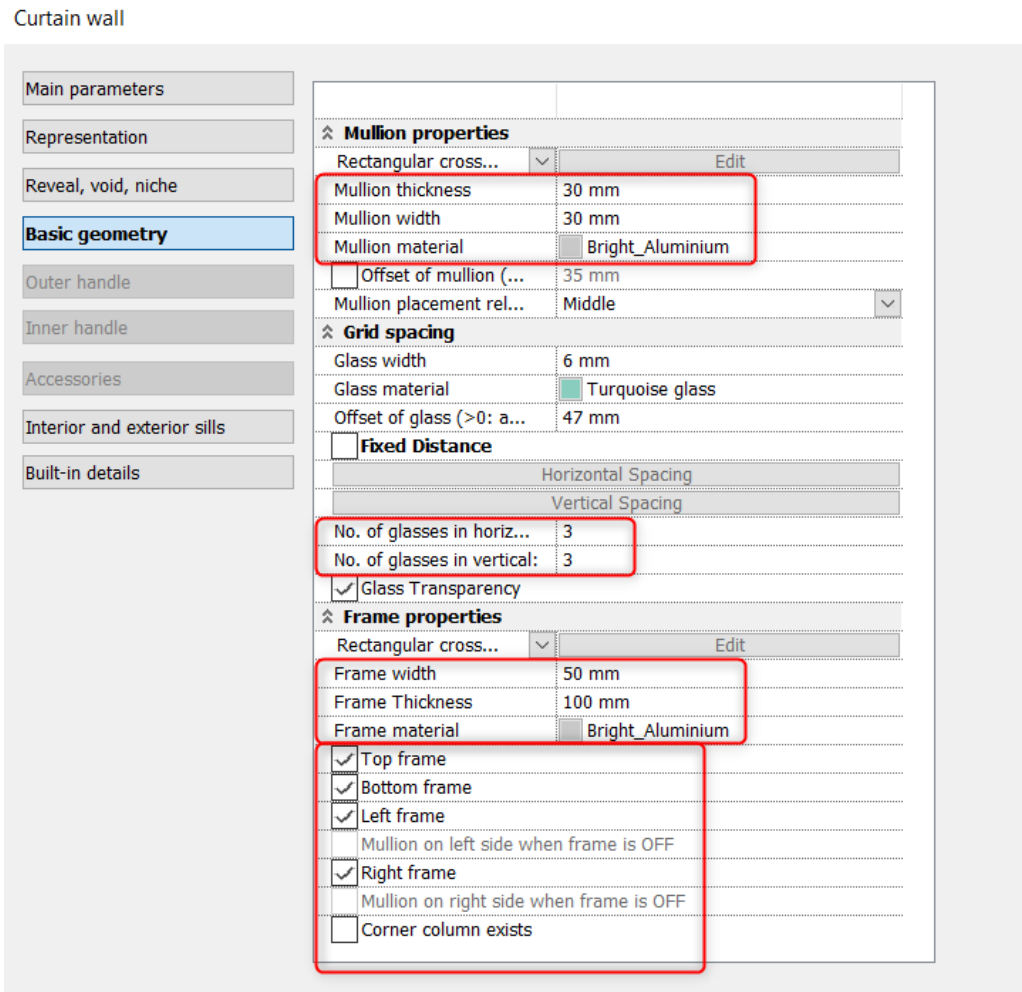

- Save the new the setting under a new style:

7.1.2. Create and edit the curtain wall

Draw the curtain wall

- Draw the curtain wall by using the Building – Curtain wall command as it is shown below. You can use the wall midline as a reference (1, 2).

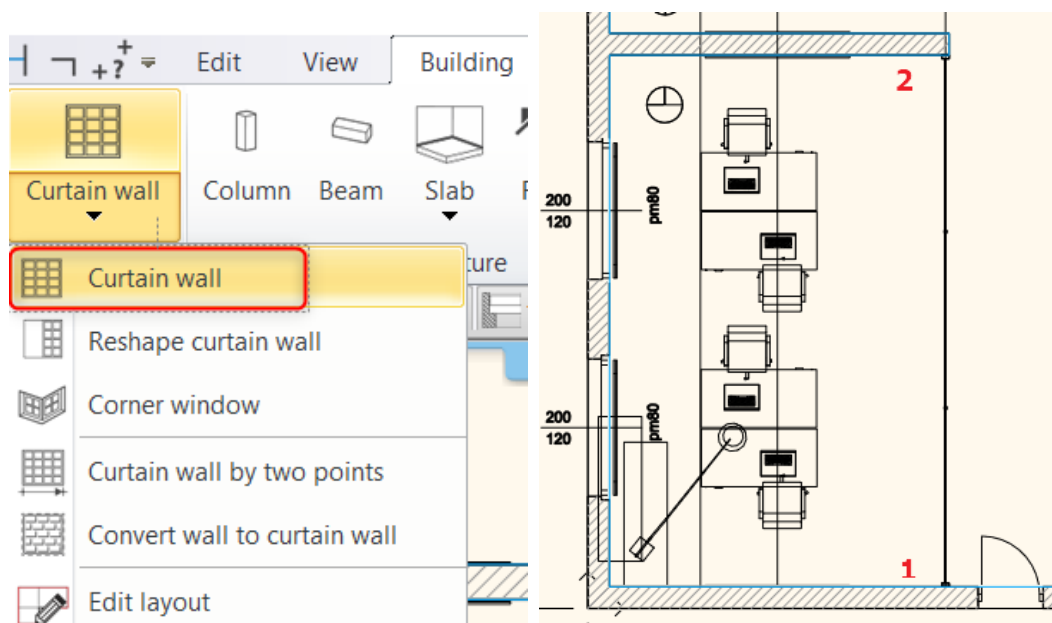

7. Workshop: Curtain walls

Insert a door

- Choose the “Single leaf glass door” from the Design Center- Building -Door- Outdoor – Glass folder and place it to the middle of the curtain wall.
- Modify the door height to 2490 mm. Set the “Distance from wall line” to 5 mm. The glass material is Turquoise glass.

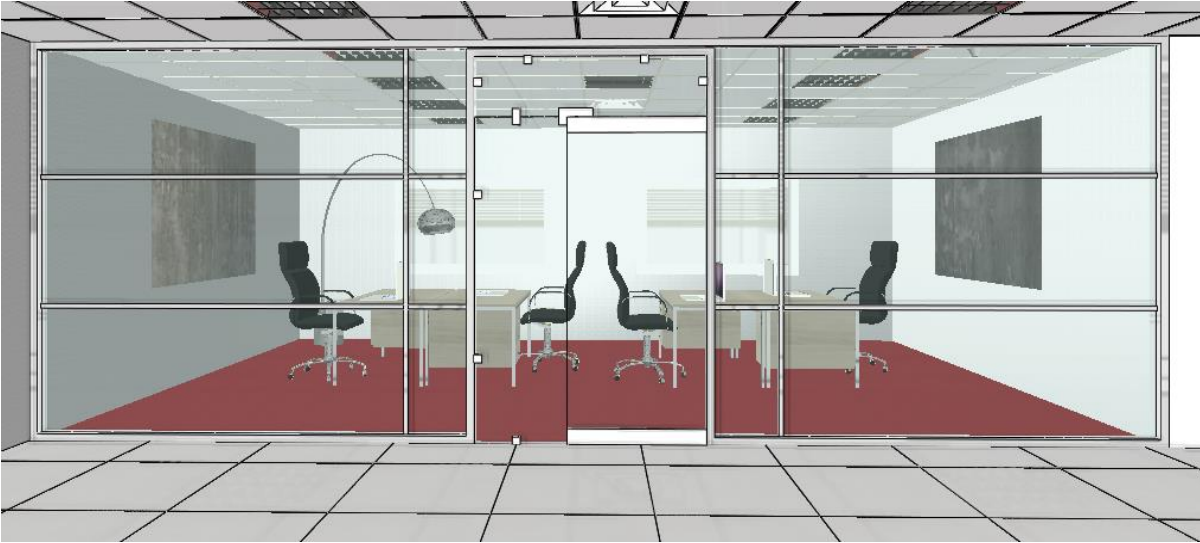

Edit layout

We can modify the divisions on the layout. Click on the side of the curtain wall which facing to the corridor; and then select the Edit layout command from the local menu.

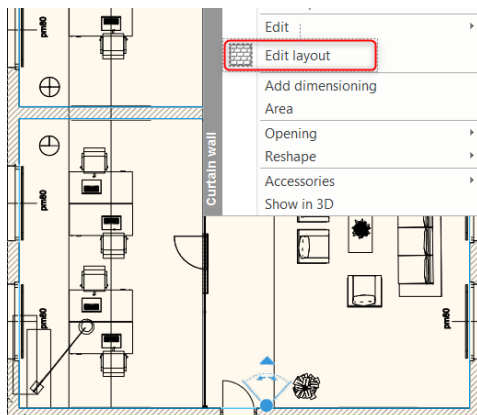

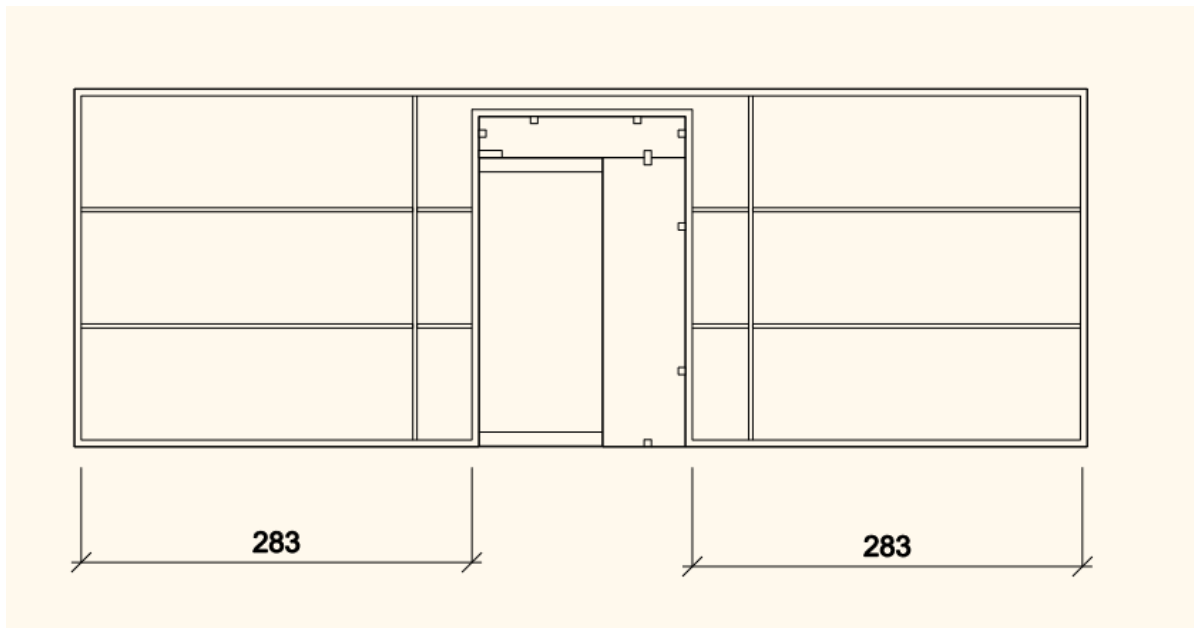

- Move the vertical mullion from the door frame, the distance is 1400 mm.

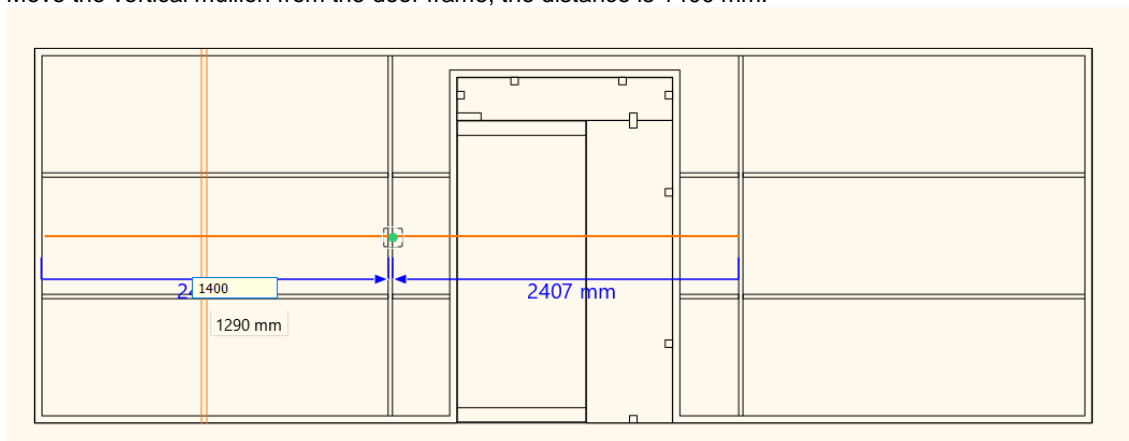

- Move the horizontal mullions towards each other by 100 mm.

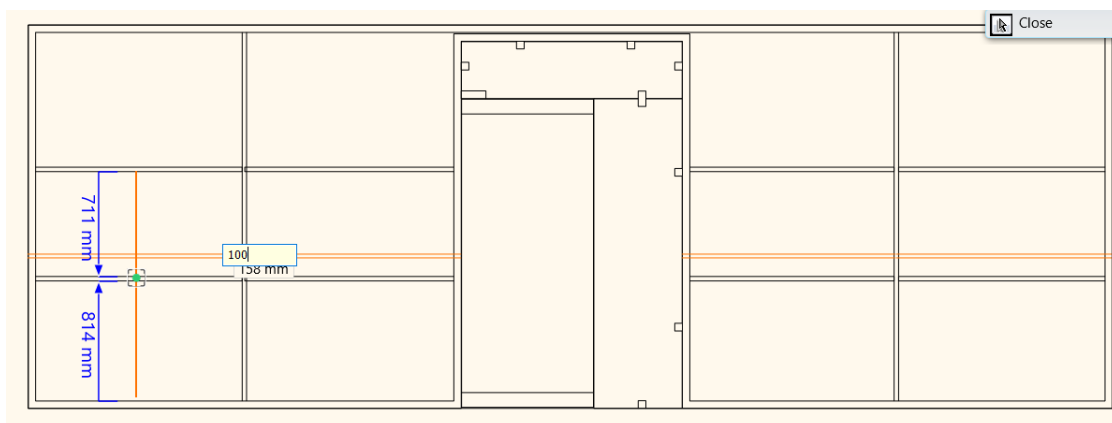

We get the following result:



7.2. Converting the 2nd office to closed-space

We separate the other office by a curtain wall with the same method, but we use different divisions in this example.

Create the curtain wall

- Draw the curtain wall by using the Building – Curtain wall command as it is shown below. You can use the wall midline as a reference (3, 4).

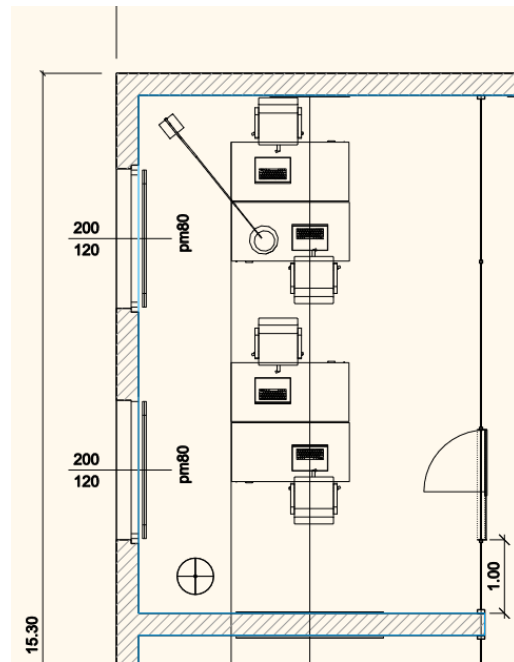
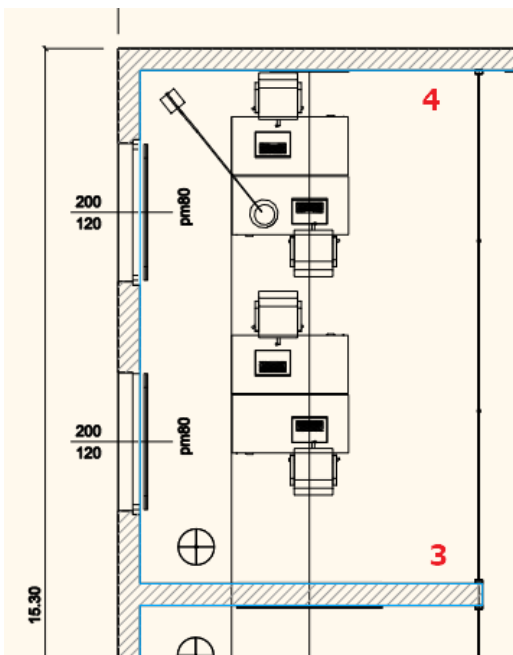

Insert a door

- Choose the “Single leaf glass door” from the Design Center- Building -Door- Outdoor – Glass folder and place it 1000 mm from the 3rd point.
- Modify the door height to 2490 mm. Set the “Distance from wall line” to 5 mm. The glass material is Turquoise glass.



Modify properties

In the Curtain wall dialogue window change the “Number of the glasses in vertical” to 1 and switch off “Bottom frame” option.



Please note that any changes in the properties dialogue window overrides the editing on the layout. Therefore, follow this order of instructions:

1. Modify properties
2. Edit layout

Curtain wall

Main parameters		
Representation		
Reveal, void, niche		
Basic geometry		
Outer handle		
Inner handle		
Accessories		
Interior and exterior sills		
Built-in details		

Mullion properties	
Rectangular cross...	▼ Edit
Mullion thickness	30 mm
Mullion width	30 mm
Mullion material	Bright_Aluminium
<input type="checkbox"/> Offset of mullion (...)	35 mm
Mullion placement rel...	Middle ▼
Grid spacing	
Glass width	6 mm
Glass material	Turquoise glass
Offset of glass (>0: a...	47 mm
<input type="checkbox"/> Fixed Distance	
Horizontal Spacing	
Vertical Spacing	
No. of glasses in horiz...	3
No. of glasses in vertical:	1
<input checked="" type="checkbox"/> Glass Transparency	
Frame properties	
Rectangular cross...	▼ Edit
Frame width	50 mm
Frame Thickness	100 mm
Frame material	Bright_Aluminium
<input checked="" type="checkbox"/> Top frame	
<input type="checkbox"/> Bottom frame	
<input checked="" type="checkbox"/> Left frame	
Mullion on left side when frame is OFF	
<input checked="" type="checkbox"/> Right frame	
Mullion on right side when frame is OFF	
<input type="checkbox"/> Corner column exists	

Redraw

7. Workshop: Curtain walls



Edit divisions on the layout

We modify the vertical mullions on the layout:

- Move the first mullion to the left side of the door.

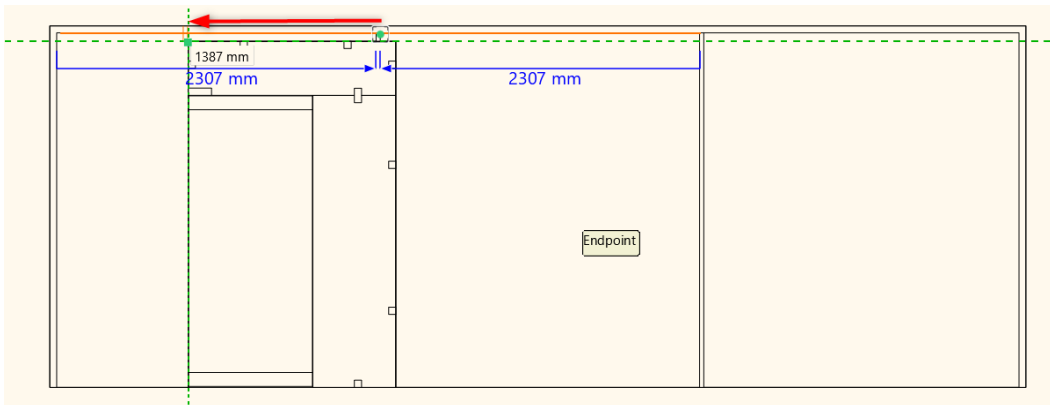

- Move a copy of the second mullion to the right side of the door.
- Move 2200 mm, the third mullion from the door frame.

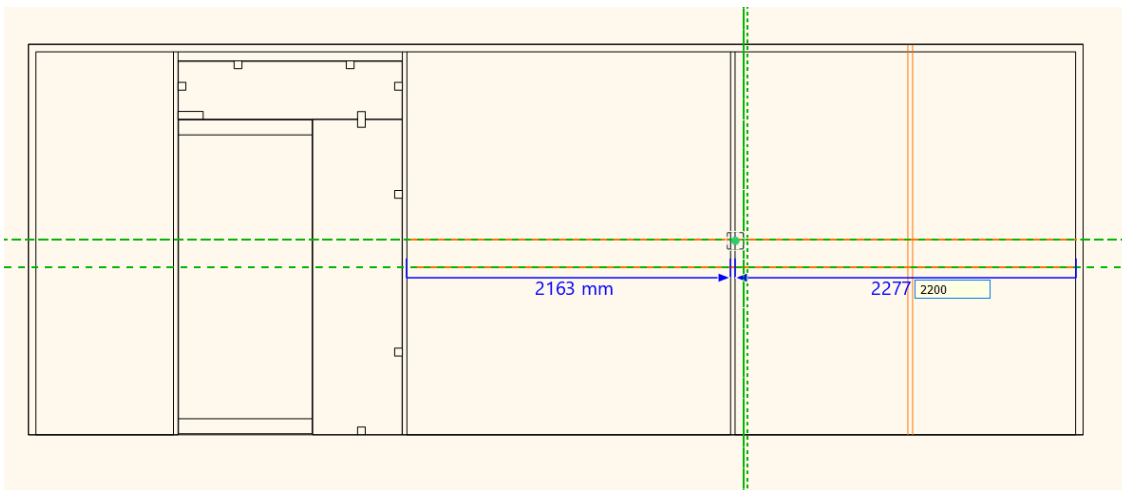

- Change the width and thickness of mullions to 40 mm. Copy these values on the mullion clipboard.
- Modify the 1st and 2nd mullion to the same values by using the Paste from mullion clipboard command.

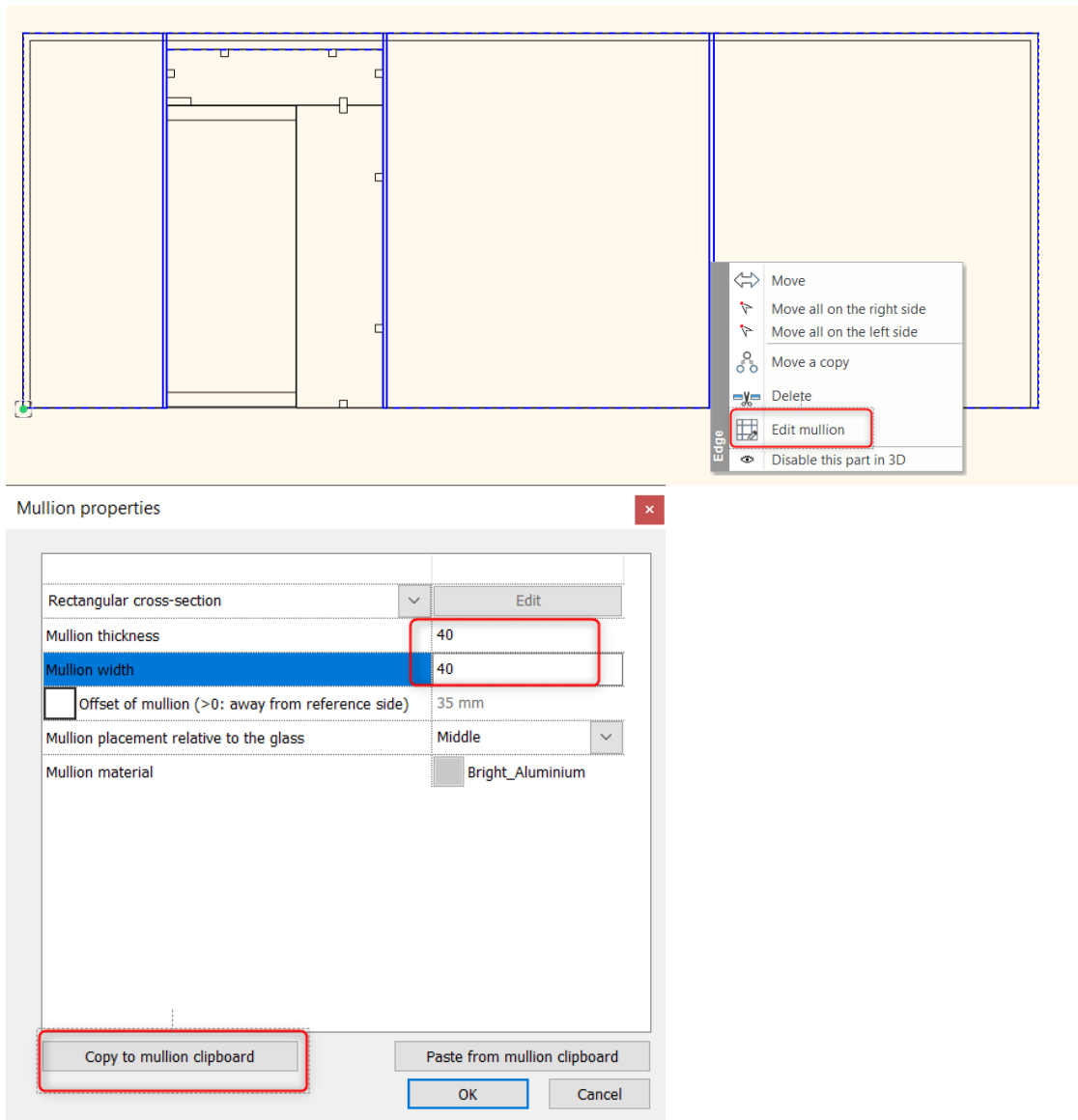

The result is the following:



7.3. Creating the meeting room

We partition the meeting room with curtain walls on two sides. This way, we form a corner room.

- At the moment, the meeting room is separated from the lounge with a wall, which is not structural. We can modify this wall.
- Modify the wall thickness to 100 mm and draw the same type of wall to separate the meeting room from the corridor.

7. Workshop: Curtain walls

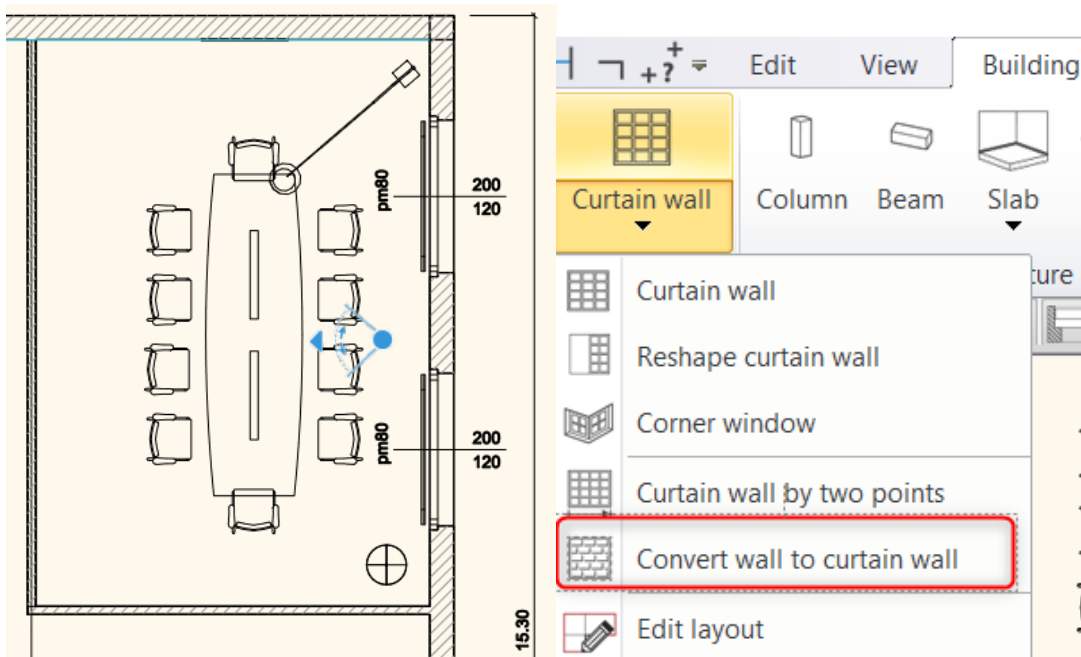

Convert wall to curtain wall

We convert two walls to curtain walls in the meeting room.

- Choose the “Convert to wall to curtain wall “ command, and then click on the two walls.



Insert a door

- Now we insert a door on the wall facing the corridor. Choose the “Single leaf glass door” from the Design Center- Building -Door- Outdoor – Glass folder and place it 1000 mm from the corner.
- Modify the door height to 2490 mm. Set the “Distance from wall line” to 5 mm. The glass material is Turquoise glass.

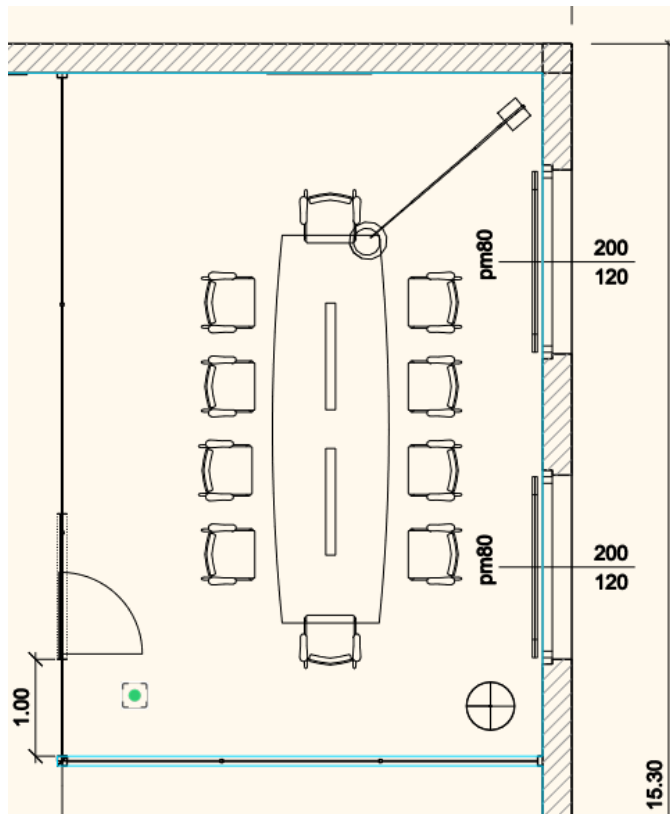

Edit divisions on the layout

- Now modify the mullions on the curtain wall on the corridor. First, delete the vertical mullions.
- Delete the mullion on the right side.
- Move 2210 mm the mullion from the left side of the wall.



- Delete horizontal mullions on the 2nd curtain wall.

7. Workshop: Curtain walls



In this example, we demonstrated three different versions of curtain walls with different divisions. On the final plan, we used the most suitable version, so we applied those settings on each of the walls.



7.4. Reshape the curtain wall

On the wall between the office spaces, we place glass blocks.

- Choose Building – Curtain wall - Reshape curtain wall command
- Click on the wall, and put the layout on the drawing on the floor plan.
- Define the first rectangle as a profile.

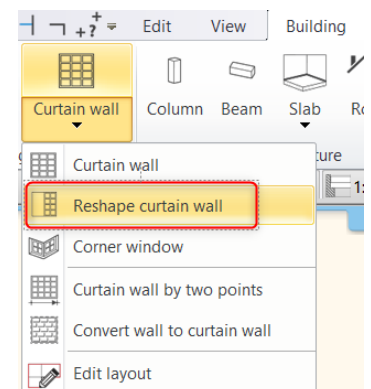

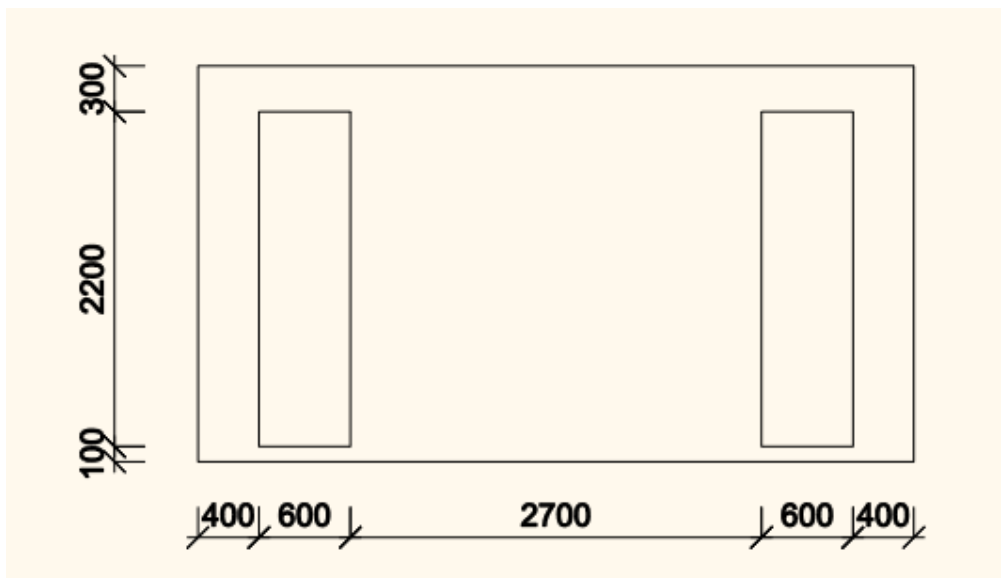

- Now set the curtain wall properties as it is shown below:

Curtain wall

Main parameters	
Representation	
Reveal, void, niche	
Basic geometry	
Outer handle	
Inner handle	
Accessories	
Interior and exterior sills	
Built-in details	

Mullion properties	
Profile cross-section	Rounded rectangle
Mullion thickness	10 mm
Mullion width	80 mm
Mullion material	g110
Offset of mullion (...)	0 mm
Mullion placement rel...	Middle
Grid spacing	
Glass width	60 mm
Glass material	Glass-20
Offset of glass (>0: a...)	10 mm
<input type="checkbox"/> Fixed Distance	
Horizontal Spacing	
Vertical Spacing	
No. of glasses in horiz...	3
No. of glasses in vertical:	11
<input checked="" type="checkbox"/> Glass Transparency	
Frame properties	
Rectangular cross...	Edit
Frame width	10 mm
Frame Thickness	80 mm
Frame material	g110
<input checked="" type="checkbox"/> Top frame	
<input checked="" type="checkbox"/> Bottom frame	
<input checked="" type="checkbox"/> Left frame	
<input type="checkbox"/> Mullion on left side when frame is OFF	
<input checked="" type="checkbox"/> Right frame	
<input type="checkbox"/> Mullion on right side when frame is OFF	
<input type="checkbox"/> Corner column exists	

Redraw

- Apply the same parameters on the second rectangle as well.

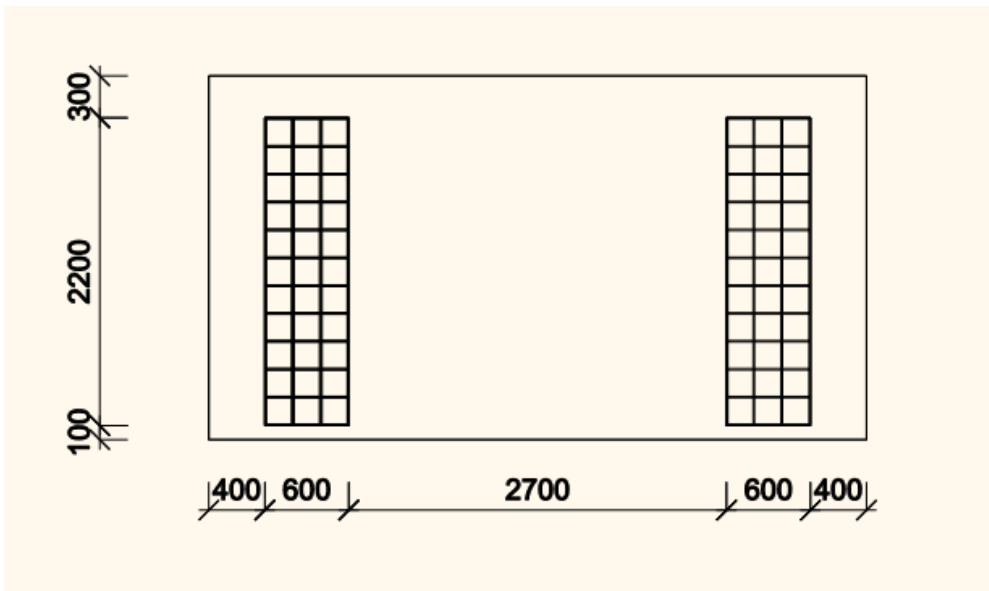

8. Workshop: Framed walls

8. Workshop: Framed walls

When adjusting the framed structure of the walls, you can create column positions, double top plates, and other similar structures that can be created by copying the original structural elements. With the help of this, a complex, parametric frame structure can be designed according to the current structural goals.

- Open the file named... \Documents\ARCHlineXP Draw\2020\Advanced_Course\8_Framed_Walls\01_Framed_Walls_Linz_Start.pro. Save the project as another.

The building in the project is made with a framed wall structure, which provides a sample of what a completed frame structure is like. All parameters of the frame structure can be freely changed and adapted to individual needs.

8.1. Creating framed walls

There are two ways to create a structure:

- ❖ Modifying an existing wall's properties

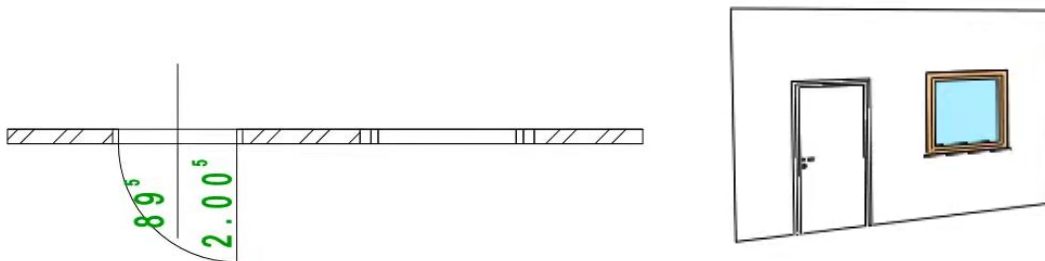

- ❖ Defining the default wall structure in the Building / Properties / Wall / Wall option.

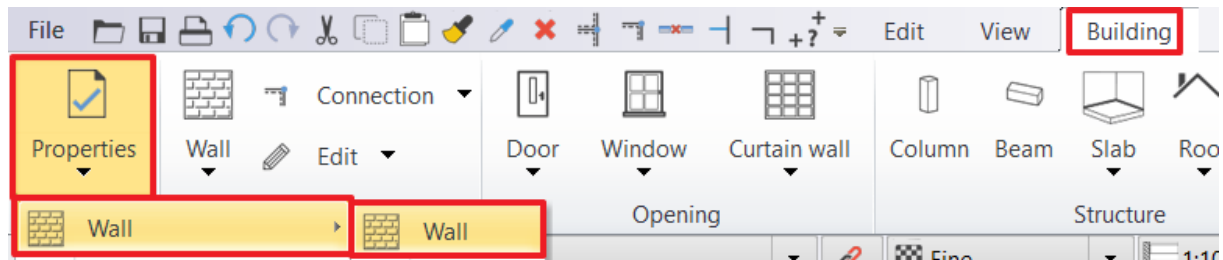

8.1.1. Setting framed wall properties

The aim of the Workshop is to build your own framed wall structure based on the existing house, which can also accommodate windows and doors.

- According to the first option, draw any single-layer wall section next to the house, then edit the wall layers in the properties as follows:
- Add two 18 mm thick layers and adjust the parameters shown in the image below.

8. Workshop: Framed walls

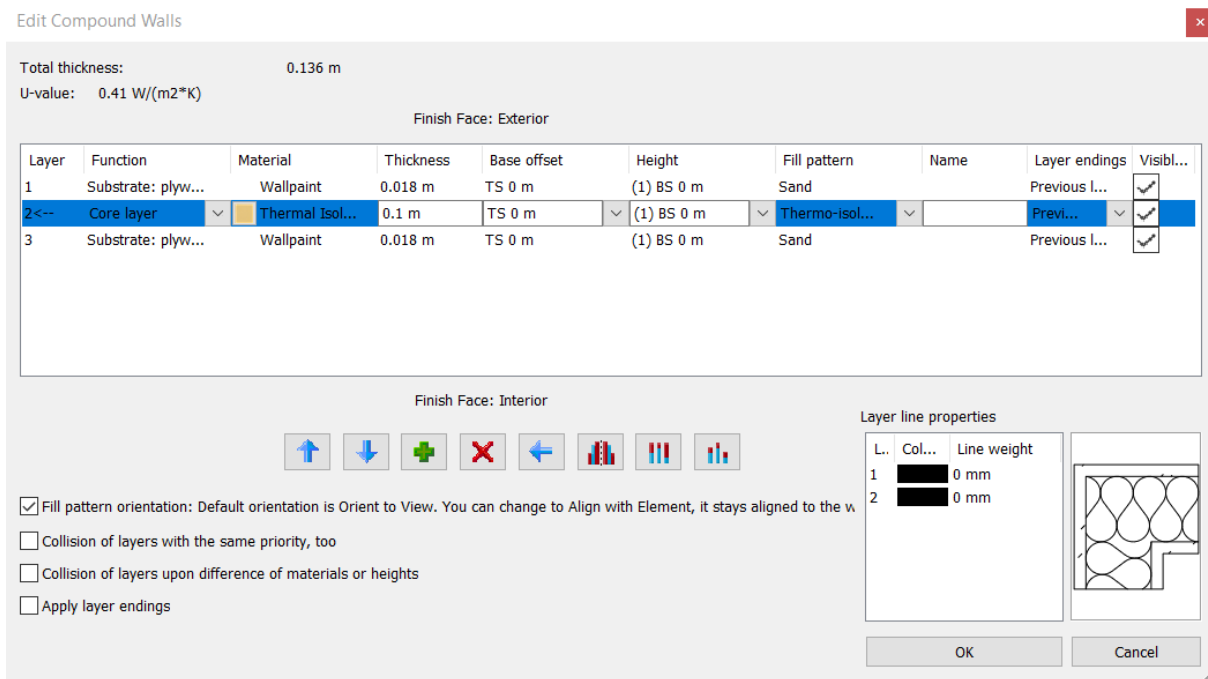

8.1.2. Setting the framed structures' properties

- When you finished setting the wall's layer structure, click on the **Wall Framing** option in the properties of the wall.

In the wall framing settings, each element can be turned on and off separately, each element is labelled with a letter, and the explanatory figure above indicates exactly where the elements are located in the structure. In the 3D preview window, the item you select in the list is marked in red on the left. The cross-section and material of the elements can also be modified individually, the special properties of some can also be edited, these settings can be accessed by clicking on the button of the corresponding element. Some parts only appear in the structure on the right side of the dialog box when a door or window is installed.

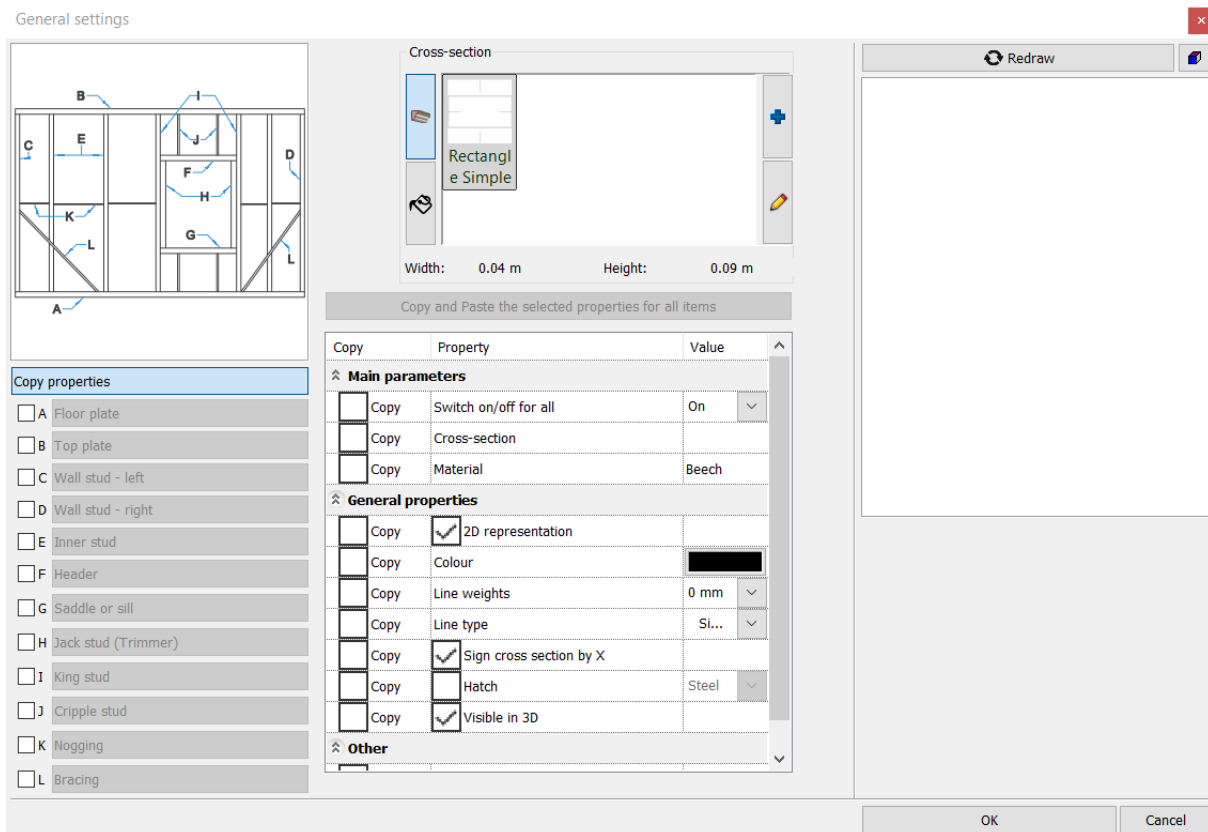

Copy properties

On this tab, you can set the general properties that will apply to each item. After changing the shape and size of the cross section and its material, under the main parameters, select the properties of the elements that you want to copy to the properties of all elements, and then use the *Copy and paste the selected properties for all items* command to make changes.

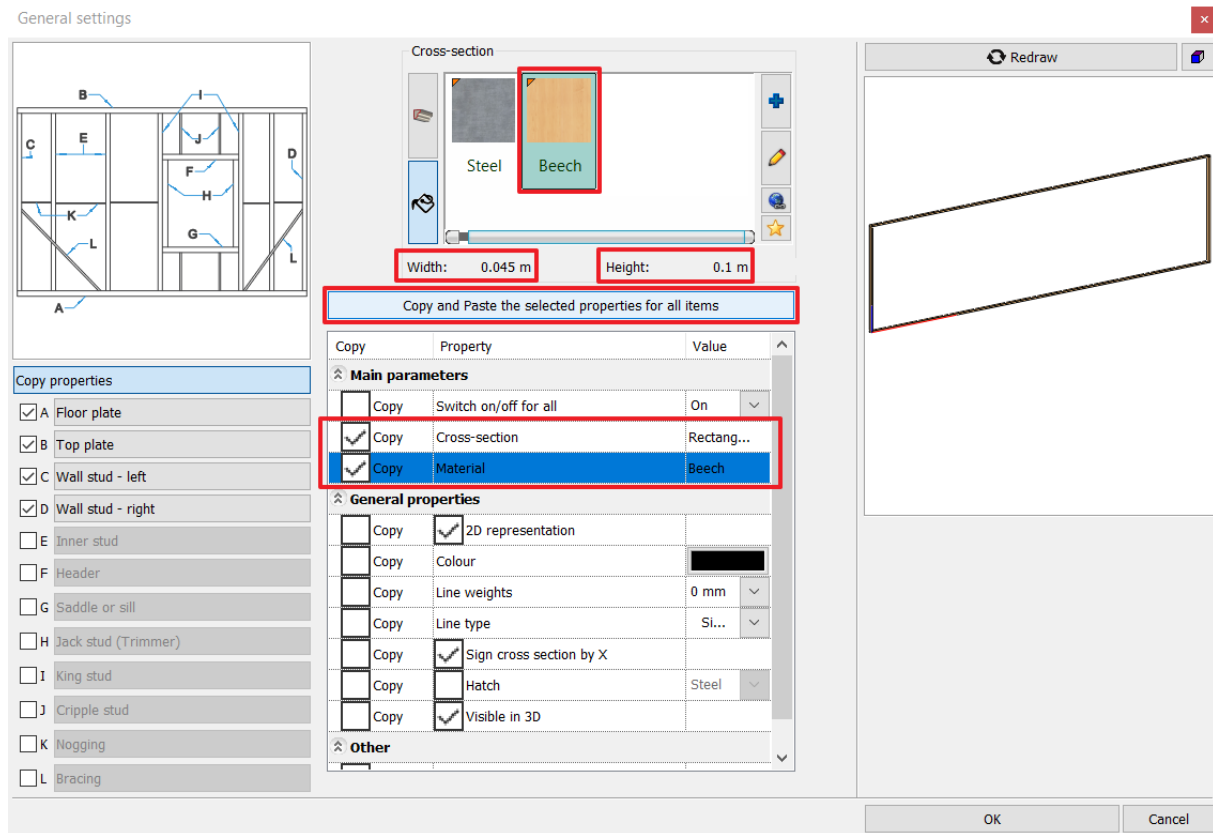

Floor plate

The floor plate is a horizontal beam at the bottom of the frame structure to which the studs are attached. It can be

assigned to a structure on several base elements by pressing the  symbol. Different parameters can be specified for each base element.

Top plate

The top plate is a horizontal beam at the top of the framed structure, the same settings are available as for the floor plate.

Wall stud – left

In addition to the size and material of the left-hand corner column, you can also change its floor plan display, and you can

turn the X on the intersecting surface on and off. The  mark can be used to add additional corner posts to the structure if needed.

Wall stud – right

The right-hand corner column has the same settings as the left-hand one.

Inner stud

In addition to the size and material and floor plan settings, there are several ways to adjust the distance between the columns in the internal column settings. You can choose to measure the distance from the axis or edge of the column and how far apart the columns should be.

Header

A bridging beam over doors and windows is required for their attachment. The number of beams can be specified, they are placed next to each other to achieve adequate stability and thickness.

8. Workshop: Framed walls

Saddle or sill

The saddle is the piece that appears at the parapet line to hold and secure the windows.

Jack stud (Trimmer)

The jack stud is the column from the saddle to the header that connects to and secures the sides of the doors and windows.

King stud

The king stud is a column running along the entire height of the structure in addition to the jack stud on either side of the doors and windows.

Cripple stud

In the case of doors and windows, vertical columns appearing under the saddle and above the header, which can be given the same settings as the inner columns.

Nogging

The nogging is a horizontal beam that increases the stability of a structure and can be incorporated into the structure in a number of ways. Either with alternating heights or with the same heights, the relative heights always denote the heights of the lowest point. These settings can also be changed freely.

Bracing

Among the properties of the bracing appearing at the edge of the structure, the location of the endpoints can be adjusted and they typically have a different size than the other elements of the structure.

- Set the properties of the frame structure listed above to the appropriate values and then accept the changes by pressing the OK button.

Like other wall properties, framed wall structure settings can be saved by creating a wall style, so you can create ready-made structures with different layer orders and framed structures that you can use in new projects by selecting the appropriate style.

8.1.3. Show only the framed structure in 3D view

The changes appear immediately in the floor plan view, and by selecting the wall in the 3D window, you can see that there is a framed structure in the wall. When displaying walls in 3D, it is possible to display only the frame structure with doors and windows, but not the wall layers and cladding. To do this, click the Build 3D model and activate the *Wall framing visible only* option.

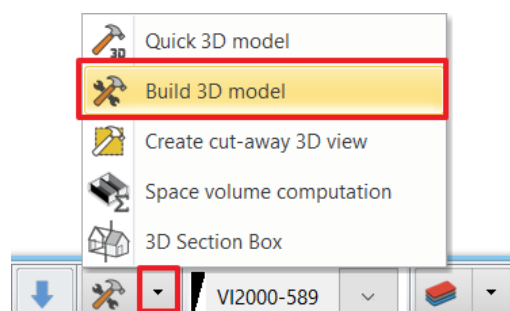
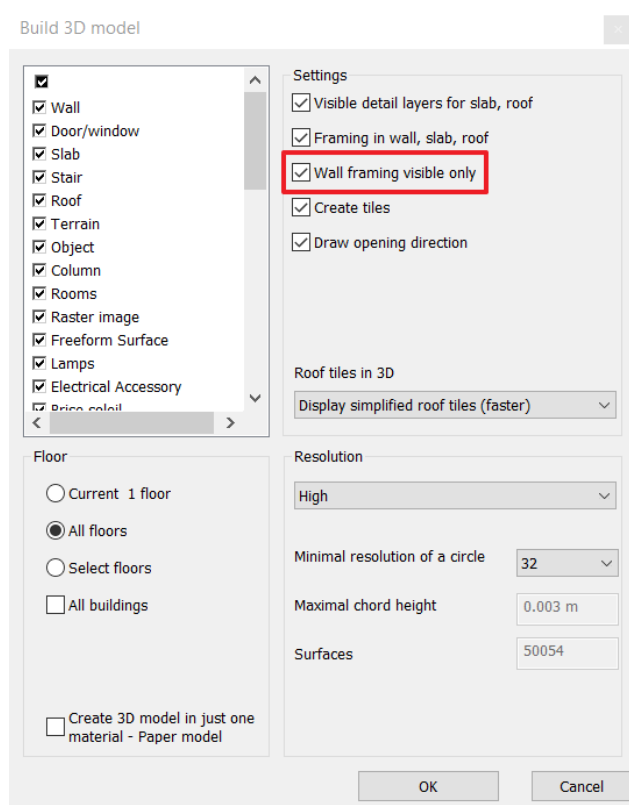

8.1.4. Shifting the framing

The default setting for the framed structure is that the centre of the framed structure is always aligned with the centre of the selected wall layer, which in some cases (for example, in the case of a two-layer overlay frame structure) is not appropriate for the design. This can be solved by the frame structure offset function, which can be set in the frame structure settings on the Properties tab for the entire structure. In the "Other" field of the property list, enter the amount of offset, then check the box and click on *Copy and Paste the selected properties for all items* option.

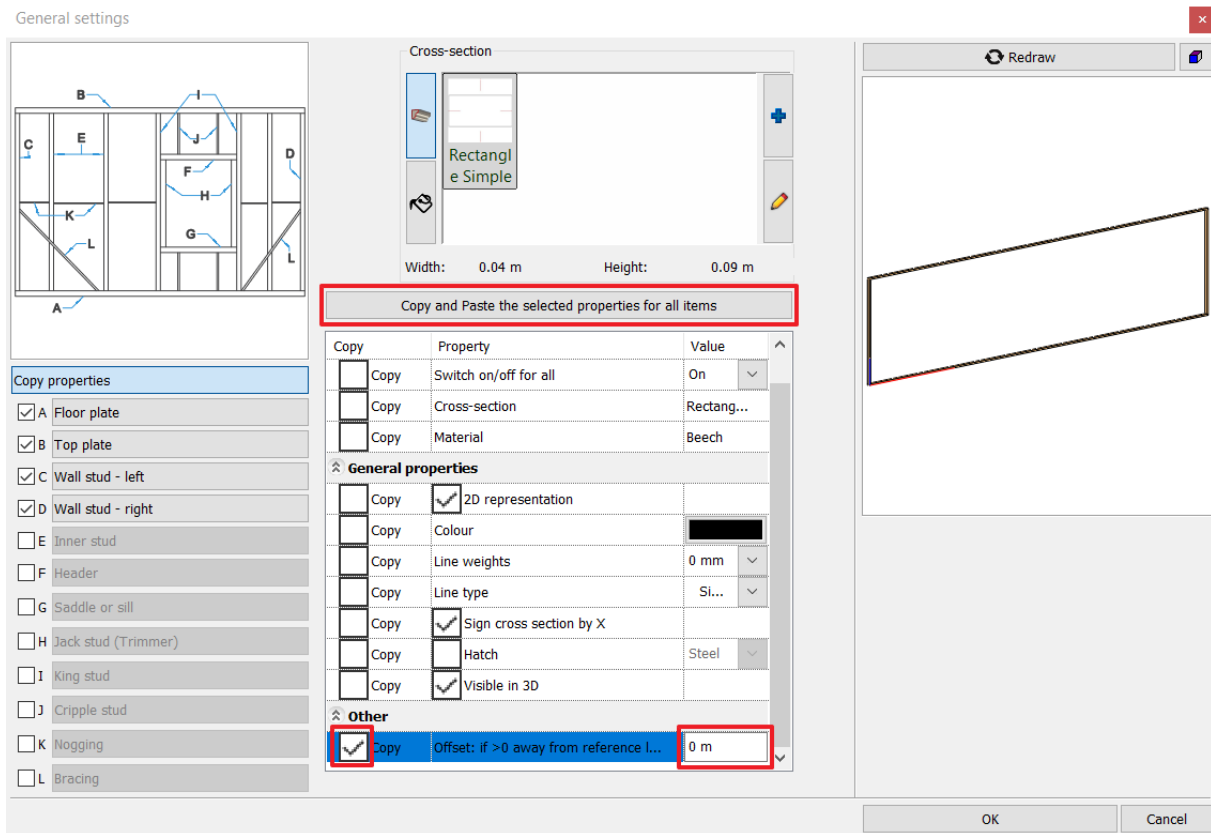

8.1.5. Placing studs in the structure manually

You can use the Building / Column command to place a column of any property individually in the frame structure. To enable this column to engage the frame structure, enable the Put in Wall option in the properties. The columns attached in this way move along with the wall as you move the wall.

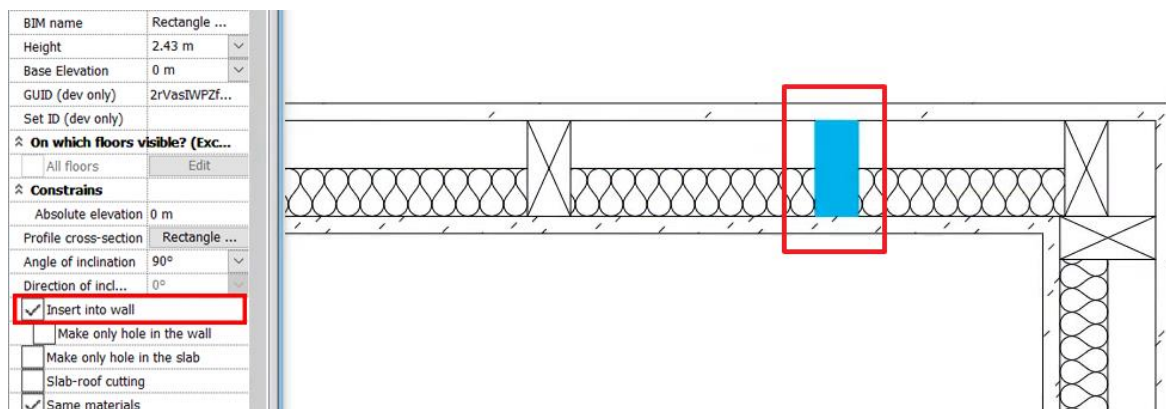

8.2. Planning with grid lines

With the help of the grid lines, it is possible to easily and quickly design framed hall buildings or any building / structure, which consists of columns and beams fitting to the mesh.

8. Workshop: Framed walls

After placing the grid lines, the columns and beams placed above the intersection points and lines automatically establish a connection with the mesh, so that the position change of the mesh lines is followed by the objects placed onto them. As a result, the workflow is significantly faster.

8.2.1. Setting the default parameters of the grid lines

You can set the properties of the grid lines in the Ribbon menu / Drafting / Properties / Grid lines option.

Allocation of the lines

In the properties you can set the distance between the horizontal and the vertical lines and how many lines to place in each direction.

Properties ✕

General properties	
Layer	Walls
Colour	
Line type	Simple Line
Type	Rectangular grid
Text style	No style
All floors	<input type="checkbox"/>
Drafting grid	
Prefix in horizontal / circular direction	
Prefix in vertical / radial direction	
Sign in horizontal / circular direction	Number
Sign in vertical / radial direction	Letter
From top to bottom	<input checked="" type="checkbox"/>
From left to right	<input checked="" type="checkbox"/>
Gap between lines in horizontal direction	3 m
Gap between lines in vertical direction	3 m
Number of lines in horizontal direction	10
Number of lines in vertical direction	10
<input checked="" type="checkbox"/> Uniform step	
Steps in horizontal direction	
Steps in vertical direction	

Styles OK Cancel

Setting the symbols of the lines

Not only can you specify the placement of the lines, but also what symbols are associated with those lines, which helps you define parts of the grid. For both vertical and horizontal lines, you can specify a letter or number, and you can specify a unique prefix for the characters you set.

Properties ✕

⌄ General properties	
Layer	Walls
Colour	██████████
Line type	Simple Line
Type	Rectangular grid
Text style	No style
All floors	<input type="checkbox"/>
⌄ Drafting grid	
Prefix in horizontal / circular direction	
Prefix in vertical / radial direction	
Sign in horizontal / circular direction	Number
Sign in vertical / radial direction	Letter
From top to bottom	<input checked="" type="checkbox"/>
From left to right	<input checked="" type="checkbox"/>
Gap between lines in horizontal direction	3 m
Gap between lines in vertical direction	3 m
Number of lines in horizontal direction	10
Number of lines in vertical direction	10
<input checked="" type="checkbox"/> Uniform step	
	Steps in horizontal direction
	Steps in vertical direction

Styles OK Cancel

8.2.2. Placing the grid lines

Use the **Drawing / Tools / Grid lines / Place** function to create the mesh.

- Place a mesh of 10 horizontal and 10 vertical lines spaced 3 meters apart, then place columns at the intersections. Also draw beams between the columns. Use duplicate commands to efficiently create large amounts of items.

8. Workshop: Framed walls

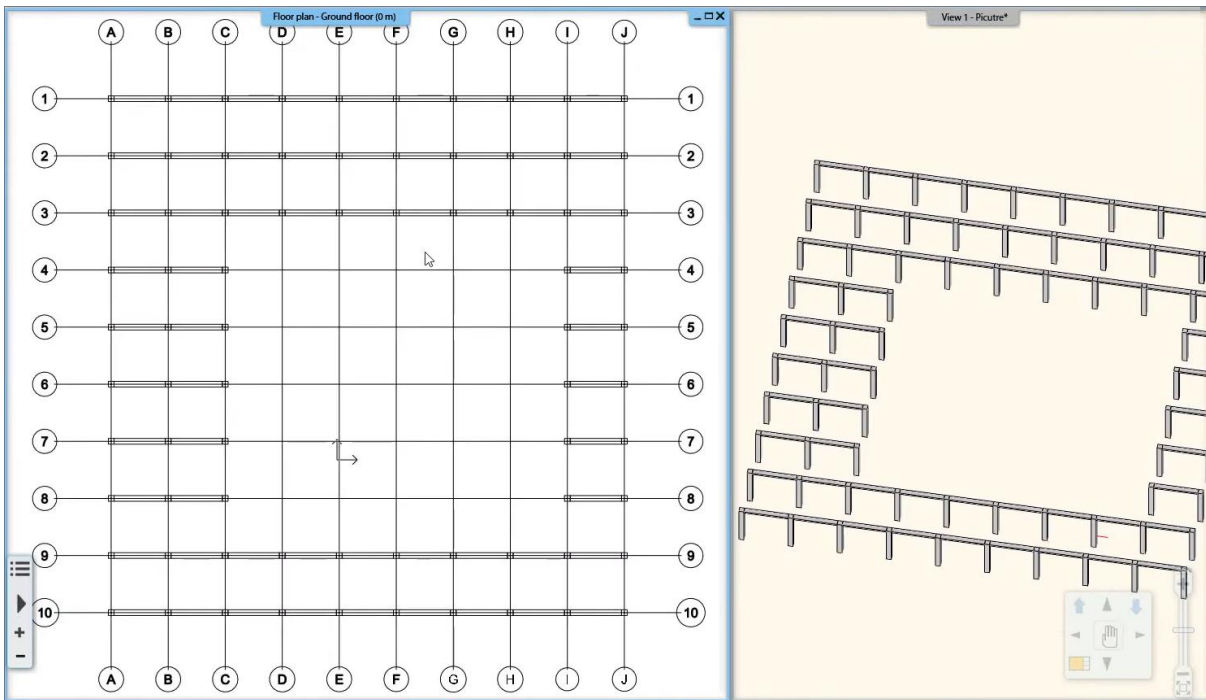

- Move any line in any direction — you can even rotate it — and observe how the elements on it follow the movement without selecting them too.

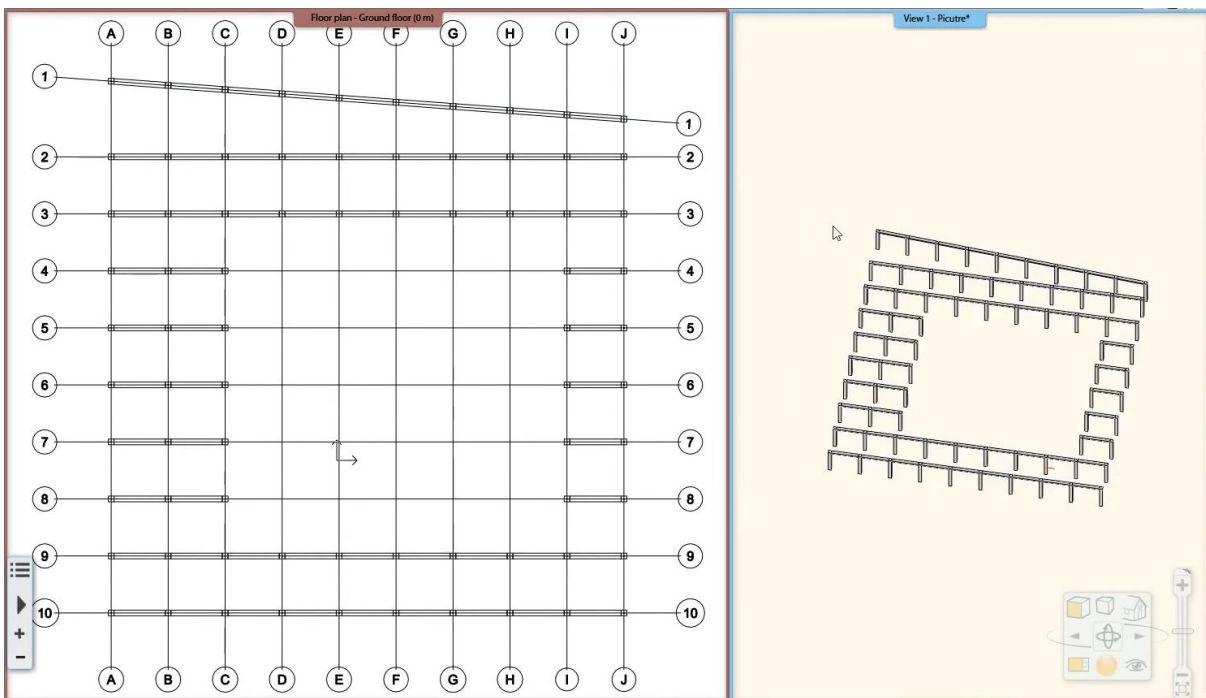

Placing circle grid

It is also possible to place a circular mesh, and the lines of the mesh can be defined with arcs. To do this, set the Type to "Radial Grid" in the properties window.

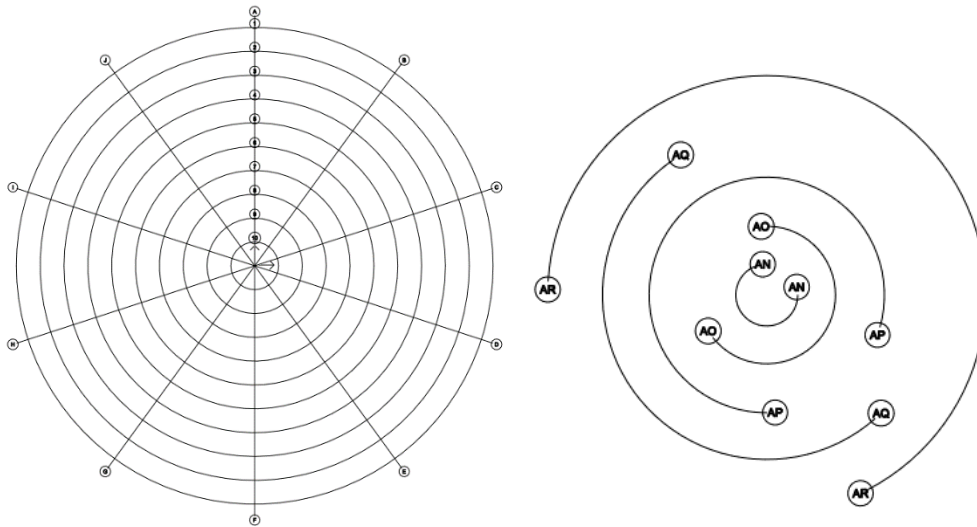

8.2.3. Expanding the grid lines

The placed grid lines appear on the floor plan according to the parameters set in its properties, but it can also be modified in all directions afterwards. The program will then automatically continue the line with the set symbols.

- ❖ With Drafting / Tools / Grid lines / Horizontal or vertical grid line, you can expand the mesh with both vertical and horizontal lines.

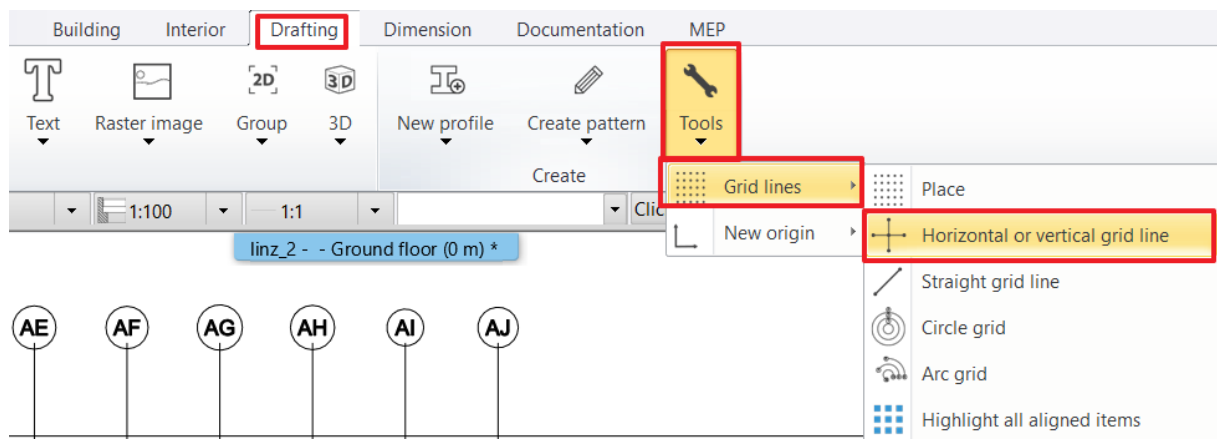

- ❖ With the **Straight grid line** option, you can place a line that complements the placed grid lines or is located in a different direction from the existing lines.

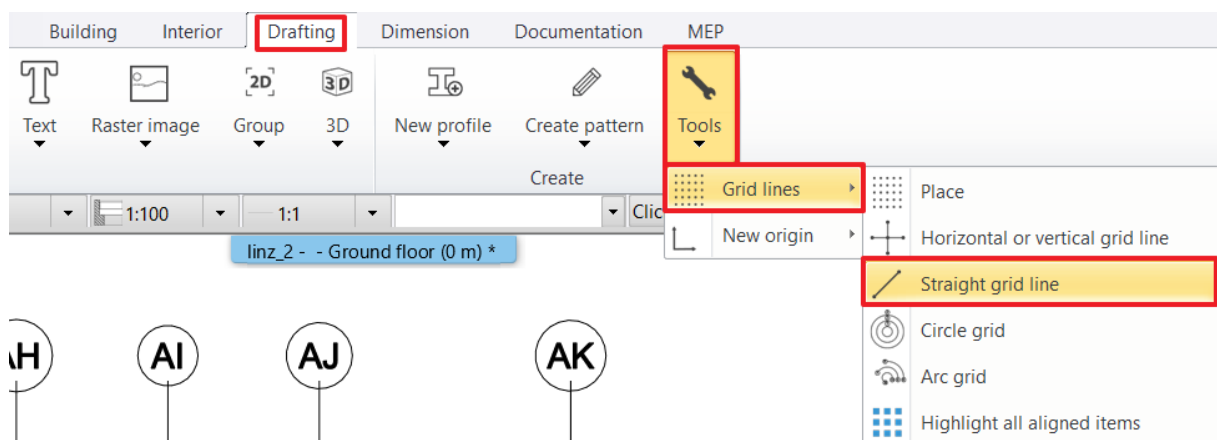

- ❖ You can also expand the grid lines with the "Offset a Copy" function in the menu of the line.

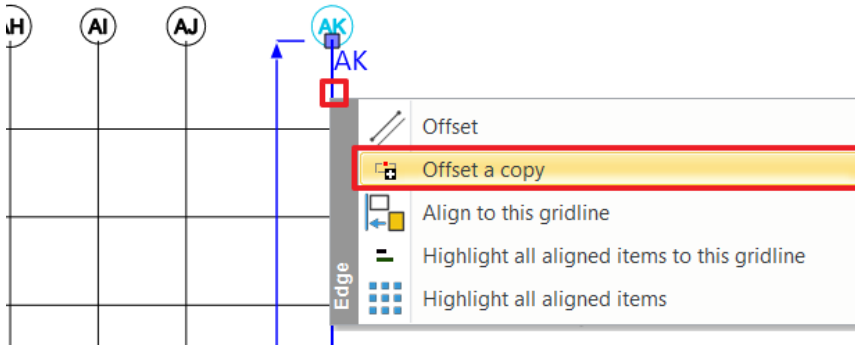

8.2.4. Checking the connected objects to the grid lines

Use Drafting / Tools / Grid lines / Highlight all aligned items to see which elements in the drawing are connected to the grid lines and which are not.

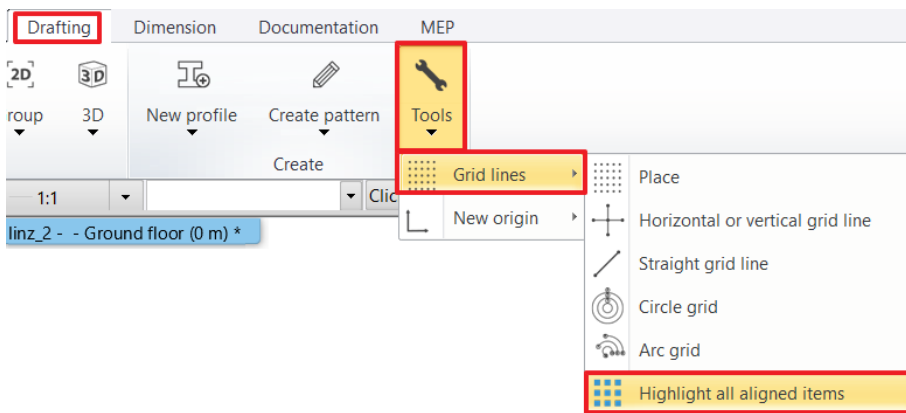

In the example below you can see that the program indicates the connected elements with green colour.

